

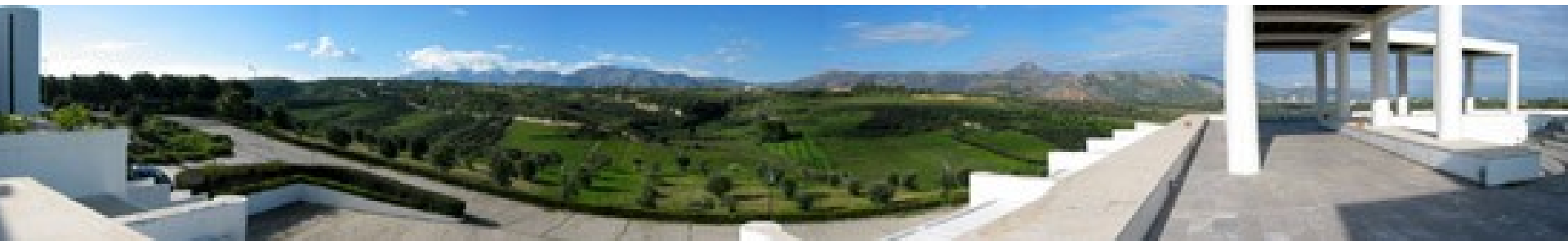

Lectures on ***Wireless Networks & Mobile Computing***
CS 439 & 539

Prof. Maria Papadopouli
University of Crete
ICS-FORTH
<http://www.ics.forth.gr/mobile>



Περιεχόμενα



Εισαγωγή στις θεμελιώδεις έννοιες σχετικά με τα παρακάτω:

- ασύρματα δίκτυα, τόσο στο φυσικό όσο και στο **MAC layer** (**radio propagation, channel, modulation**)
- **συστήματα εύρεσης θέσης** (positioning systems)
- ασύρματες τεχνολογίες (πχ **IEEE802.11**, WiMAX, UWB, Bluetooth, RF tags, sensors, LTE)
- αρχιτεκτονικές/μοντέλα πρόσβασης
 - στην πληροφορία (πχ mobile peer-to-peer systems, infostations) , και
 - ασύρματων δικτύων (πχ ad hoc, mesh, sensor, infrastructure networks),
- πρωτόκολλα δρομολόγησης σε ασύρματα δίκτυα (routing protocols)
- **εφαρμογές για κινητά υπολογιστικά συστήματα** (πχ social networking & location-based εφαρμογές πάνω σε Android, ambient intelligence)
- εποπτεία ασύρματων δικτύων και ανάλυση της απόδοσης τους
- θέματα μοντελοποίησης των ασύρματων δικτύων
- **cognitive radios**
- **Spectrum & wireless access markets and business issues**

Short CV



Originally from Heraklio, Crete, Greece

- B.Sc. **University of Crete** (1992)
- M.Sc. **New York University** (1994)
- Ph.D. **Columbia University** (2002)

Ph.D. Thesis “Resource sharing in mobile wireless networks”

Advisor: Prof. Henning Schulzrinne

- Assistant Professor, **University of North Carolina at Chapel Hill** (2002-2006)
- Research Associate, **Foundation for Research & Technology-Hellas** (2004-)
- Associate Professor, **University of Crete** (2005-)
- Guest Full Professor, KTH Royal Institute of Technology (2011-)

Research interests:

wireless networks, measurements & modeling, mobile computing, positioning

Wireless access markets

Εισαγωγικά - Δομή



Δεν είναι ένα συνηθισμένο μάθημα!

Οι φοιτητές θα χρειαστεί να διαβάσουν από διάφορες πηγές:

- Υλικό online (διαλέξεις, papers)
- Κεφάλαια βιβλίων

Περιλαμβάνει τόσο **θεωρητικές** όσο και **πρακτικές ασκήσεις**.

Θα γίνουν **διαλέξεις από τους φοιτητές**

Θα γίνουν διαλέξεις από τους μεταπτυχιακούς φοιτητές/βοηθούς και εργαστήρια

Αν έχουμε Erasmus φοιτητές, οι διαλέξεις θα γίνονται στα αγγλικά

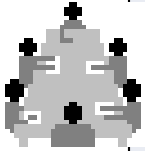

- Georgios Fortetsanakis geforte@ics.forth.gr
- Michalis Katsarakis katsarakis@csd.uoc.gr



Εισαγωγικά – Εργαστήρια

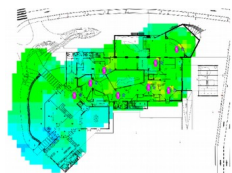
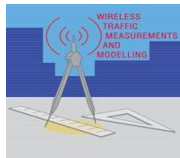

- Εποπεία ασύρματου δικτύου
- Φυσικό επίπεδο - Radio propagation – measurements
- Στατιστική ανάλυση & επεξεργασία δικτυακών δεδομένων
- Συστήματα εύρεσης θέσης
- Mobile computing applications

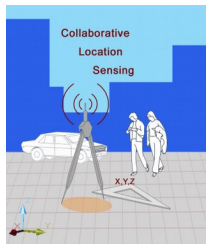

Project 1:

Εποπτεία ασύρματου δικτύου



- Θα στήσετε testbed για την παρακολούθηση και την καταγραφή δεδομένων σχετικά με την κίνηση και την πρόσβαση χρηστών σε ένα ασύρματο δίκτυο.
- Θα εξοικειωθείτε με προγράμματα εποπτείας (π.χ., *tcpdump*, *wireshark*, *iwlist*, *snmp*, *syslogs*) καθώς επίσης και με την συλλογή δεδομένων.

Project 2: Στατιστική ανάλυση & επεξεργασία δικτυακών δεδομένων

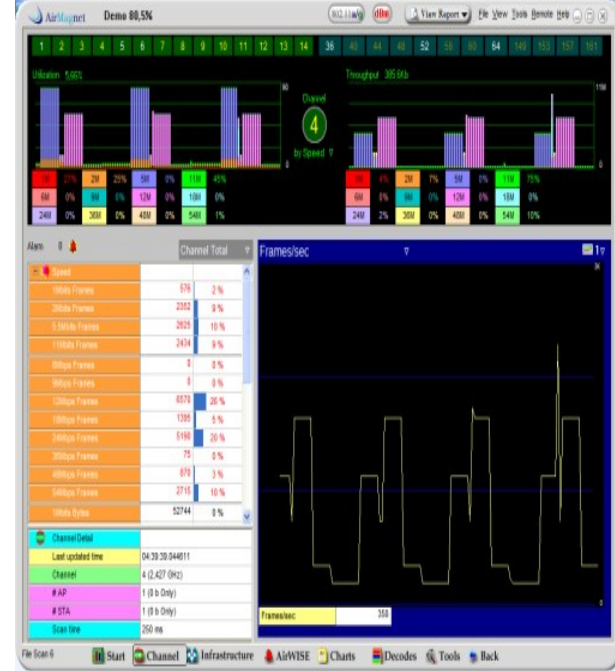

- Δεδομένα που έχουν καταγραφεί σε ασύρματα δίκτυα με διάφορα προγράμματα εποπτείας δικτύων (Project 1), θα τα αναλύσετε στατιστικά με σκοπό την εξαγωγή συμπερασμάτων για το δίκτυο.
- Θα εξοικειωθείτε με *matlab* & απλές στατιστικές συναρτήσεις (πχ υπολογισμό mean, median, Cumulative Distribution Function, fitting κατανομών)

Project 3: Φυσικό επίπεδο - Radio propagation - measurements

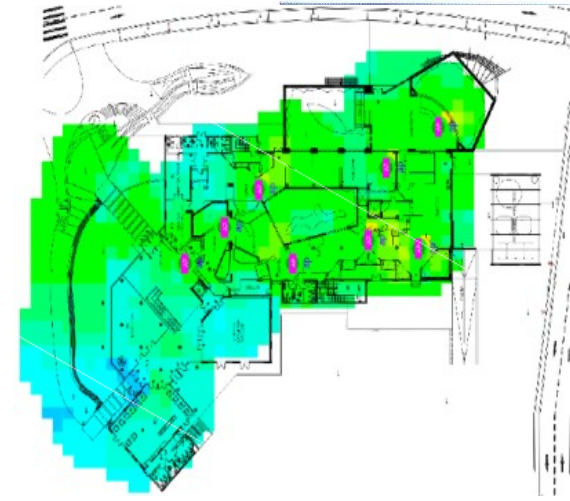

- Παρακολούθηση και μέτρηση της τιμής της έντασης του σήματος.
- Εξέταση φαινομένων που επηρεάζουν τη διάδοση (π.χ., απόσταση μεταδότη/δέκτη, φαινόμενα ανάκλασης, απορρόφησης και εξασθένησης).
- Καταγραφή αυτών των μετρήσεων και μελέτη της επίδραση των παραπάνω φαινομένων και την συσχέτιση τους με τις τιμές του signal strength.

Project 4 - Συστήματα εύρεσης θέσης



- Εξοικείωση με διάφορες τεχνολογίες που χρησιμοποιούνται για location-sensing.
 - Πειραματισμός με
IEEE802.11, RFIDs, QR/barcodes, Wii και κάμερες
- Ανάλυση της fingerprinting μεθόδου και κάποιων που βασίζονται στην απόσταση

Project 5: Mobile computing applications



- Επέκταση υπαρχόντων ή υλοποίηση νέων πρωτότυπων εφαρμογών που τρέχουν σε κινητά τηλέφωνα
Προγραμματισμός σε Android διαφόρων social networking & location-based εφαρμογών.

Research Projects



- Development of the u-map: a user-centric grass-root data base with cross-layer information about user access and quality-of-experience (QoE) for various applications (systems project)
- Spectrum markets
 - Business-driven assessment of spectrum markets (in matlab)

Εισαγωγικά - Βαθμός



- Εργαστηριακές ασκήσεις (projects) **40%**
θα δοθεί κώδικας έτοιμος, πάνω στον οποίο θα υλοποιήσετε το project σας
Ομάδες 2-3 ατόμων, και ατομικά projects
Sharing of the infrastructure (e.g., Android phones)
- Τελικός (Final exam) **35-50%** (βαθμός > 4.5, για να περάσει κάποιος το μάθημα)
- Πρόοδος (15%) προαιρετική
- Παρουσίαση **10%** (Presentation)

Large-scale Wireless Testbeds



Experimenting with
state-of-the-art wireless technologies

Wireless testbeds based on IEEE 802.11

- UNC campus (with **> 900 APs**, 20,000 users)
- Iraklion (area of **150 Km²**)
- **ambient technology space** at FORTH

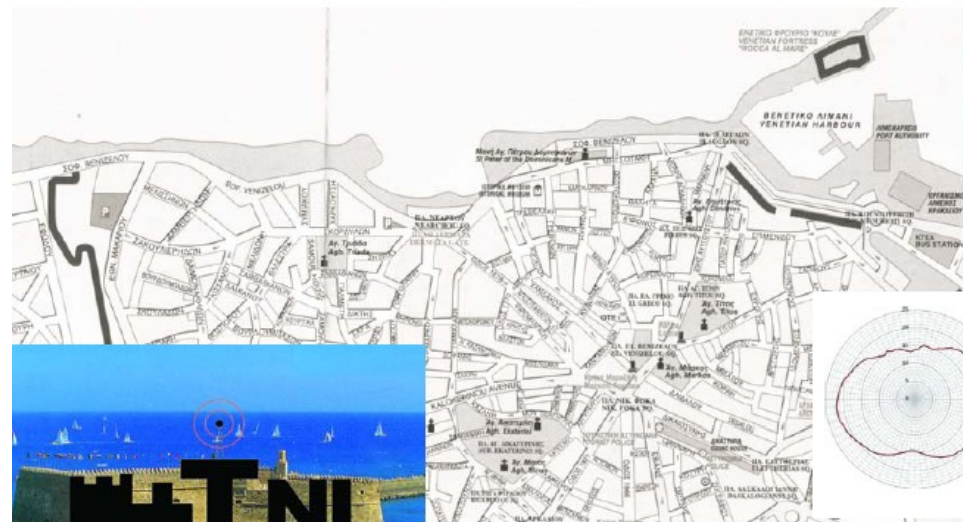

Telecommunications & Networks LAB

ICS-FORTH



Spectrum analyzers

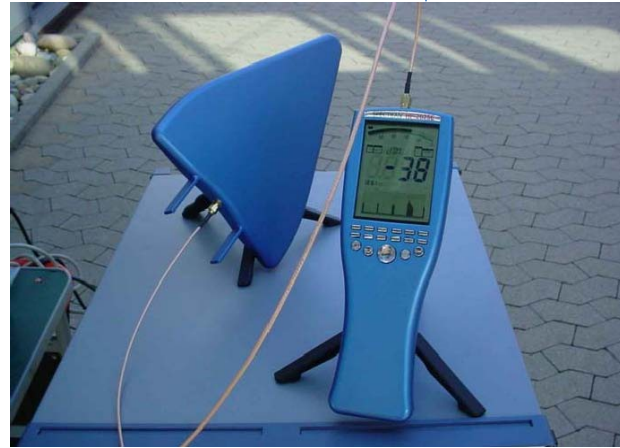

Airmagnet survey & planner

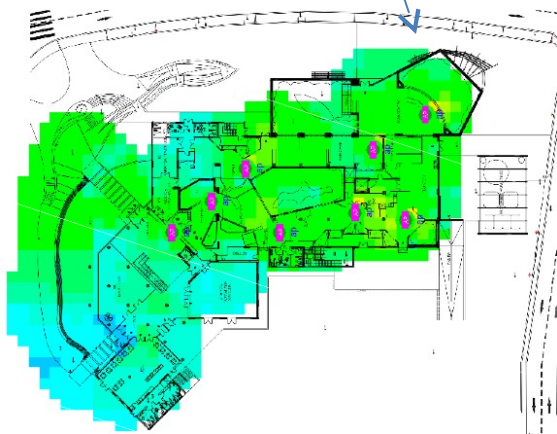

AMS
airmagnet
analyzers



Wireless Mesh Testbed @ Heraklion



- Deployed by ICS-FORTH
- The green line indicates the management/monitoring network, the blue line indicates the operational network, while the red line shows the under-development part of the network

Agenda



- **Introduction on Mobile Computing & Wireless Networks**
- Wireless Networks - Physical Layer
- IEEE 802.11 MAC
- Wireless Network Measurements & Modeling
- Location Sensing
- Performance of VoIP over wireless networks
- Mobile Peer-to-Peer computing

General Objectives



- Build some background on wireless networks, IEEE802.11, positioning, mobile computing
- Explore some research projects and possibly research collaborations

Wireless Networks & Mobile Computing



Lecture on *Introduction on Mobile Computing*

Prof. Maria Papadopouli

University of Crete

ICS-FORTH

<http://www.ics.forth.gr/mobile>

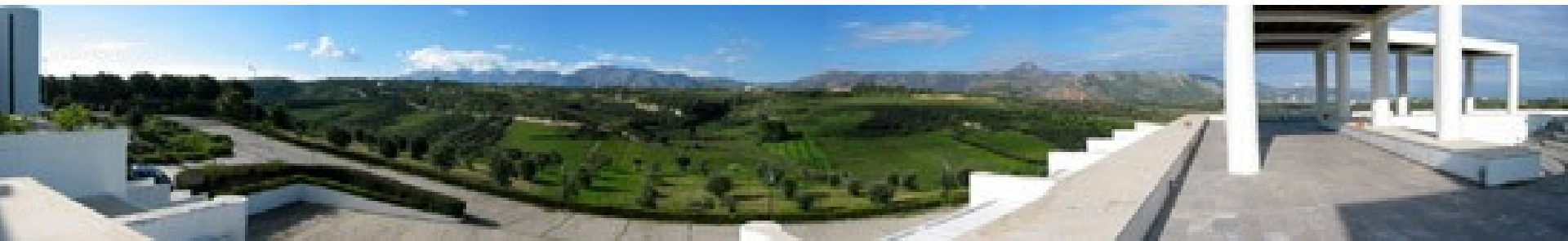

Profound technologies



**“ The most profound technologies are those that disappear.
They weave themselves into the fabric of everyday life until
they are indistinguishable from it.”**

Mark Weiser, 1991

Weiser's vision



- The creation of environments saturated with computing and communication capability yet gracefully integrated with human users
- After two decades of hardware progress, many critical elements of pervasive computing that were exotic in 1991 are now viable commercial products: handheld and wearable computers, wireless LANs, and devices to sense and control appliances
- Well-positioned to begin the quest for Weiser's vision

Constraints in Pervasive Computing



The most precious resource in a computer system is no longer its processor, memory, disk or network. Rather, it is a resource not subject to Moore's law:

User Attention

Today's systems distract a user in many explicit & implicit ways, thereby reducing his/her effectiveness.

- Understand the quality-of-experience (QoE) for a service
it is not just a simple set of QoS metrics (e.g., bandwidth, delay, packet loss)
- Define the user utility function!

Pervasive computing – Smart spaces



- Pervasive computing is the **method of enhancing computer use** by making many computers available throughout the **physical environment** but **effectively invisible to the user**.
- Pervasive computing spaces involve **autonomous networked heterogeneous** systems operating with **minimum human intervention**

Monitoring the environment

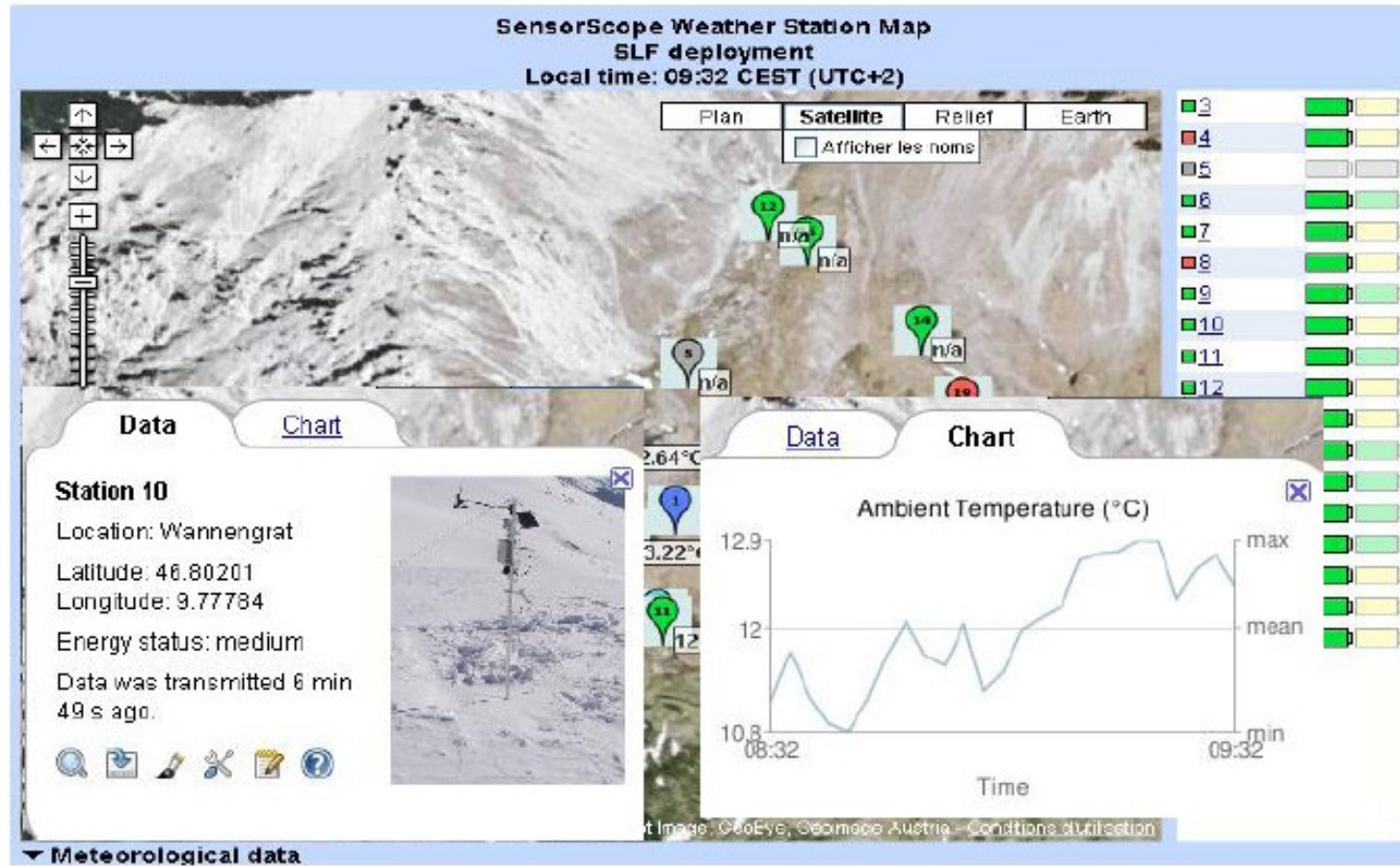

Source: Joao Da Silva's talk at Enisa, July 20th, 2008

Tagged products



Source: Joao Da Silva's talk at Enisa, July 20th, 2008

A new Wave of Visualisation and Search Devices



Source: Joao Da Silva's talk at Enisa, July 20th, 2008

3D: the next frontier

- ❖ Multiplicity of Virtual World Platforms, 60 M users estimate
- ❖ Confluence of trends: social networks, user generated content, immersive experience, rich media
- ❖ 3D pioneered through Games
- ❖ A possible approach to information overload
- ❖ New business perspectives

Level of Interaction ↑



Source: Joao Da Silva's talk at Enisa, July 20th, 2008

New networking paradigms for efficient search and sharing mechanisms



Source: Joao Da Silva's talk at Enisa, July 20th, 2008

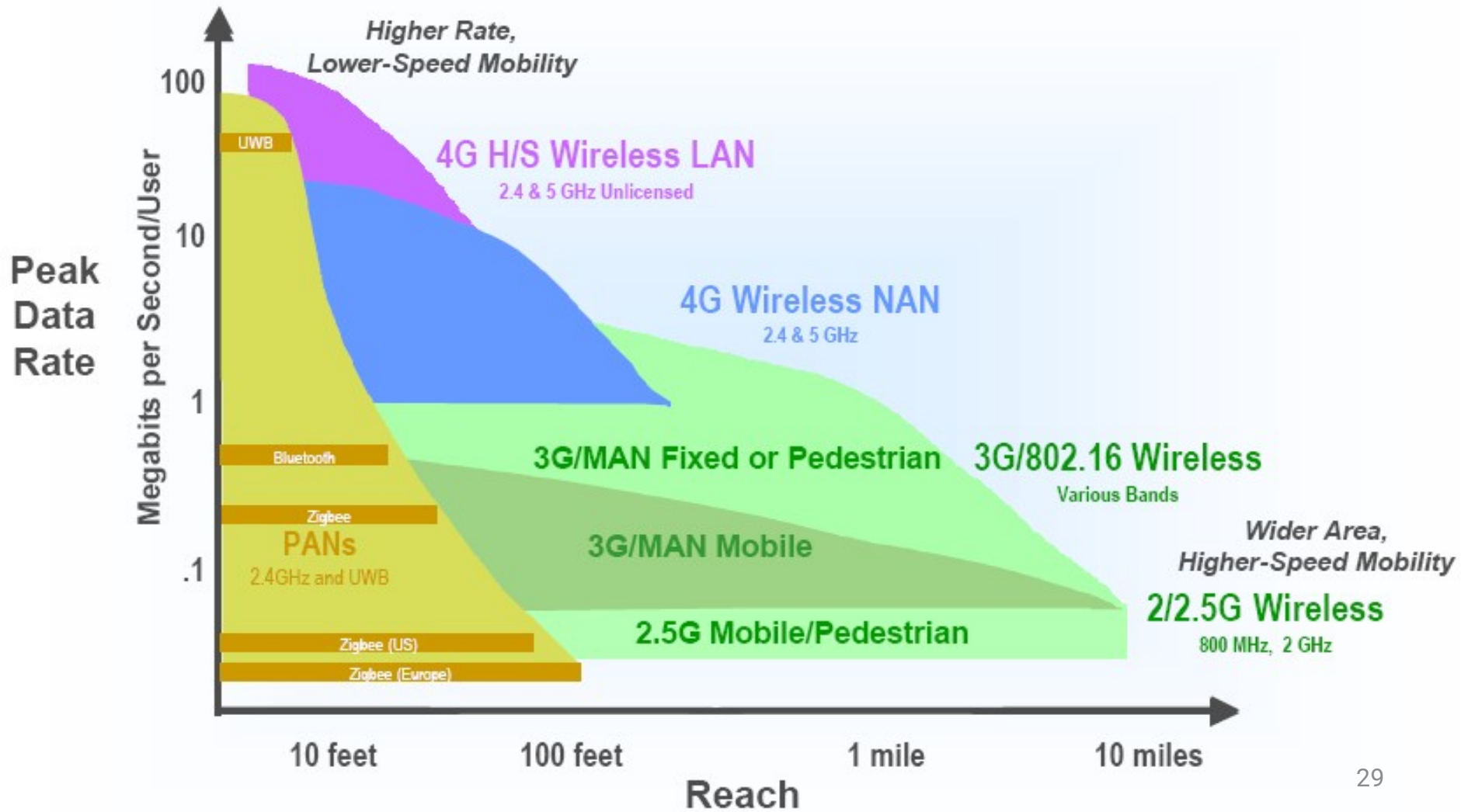

Info "Half-Life" & "Inconvenience Threshold"

"Half-Life" of Perceived Personal Information Value

"Inconvenience Threshold" Travel Distance to Obtain Valuable Information

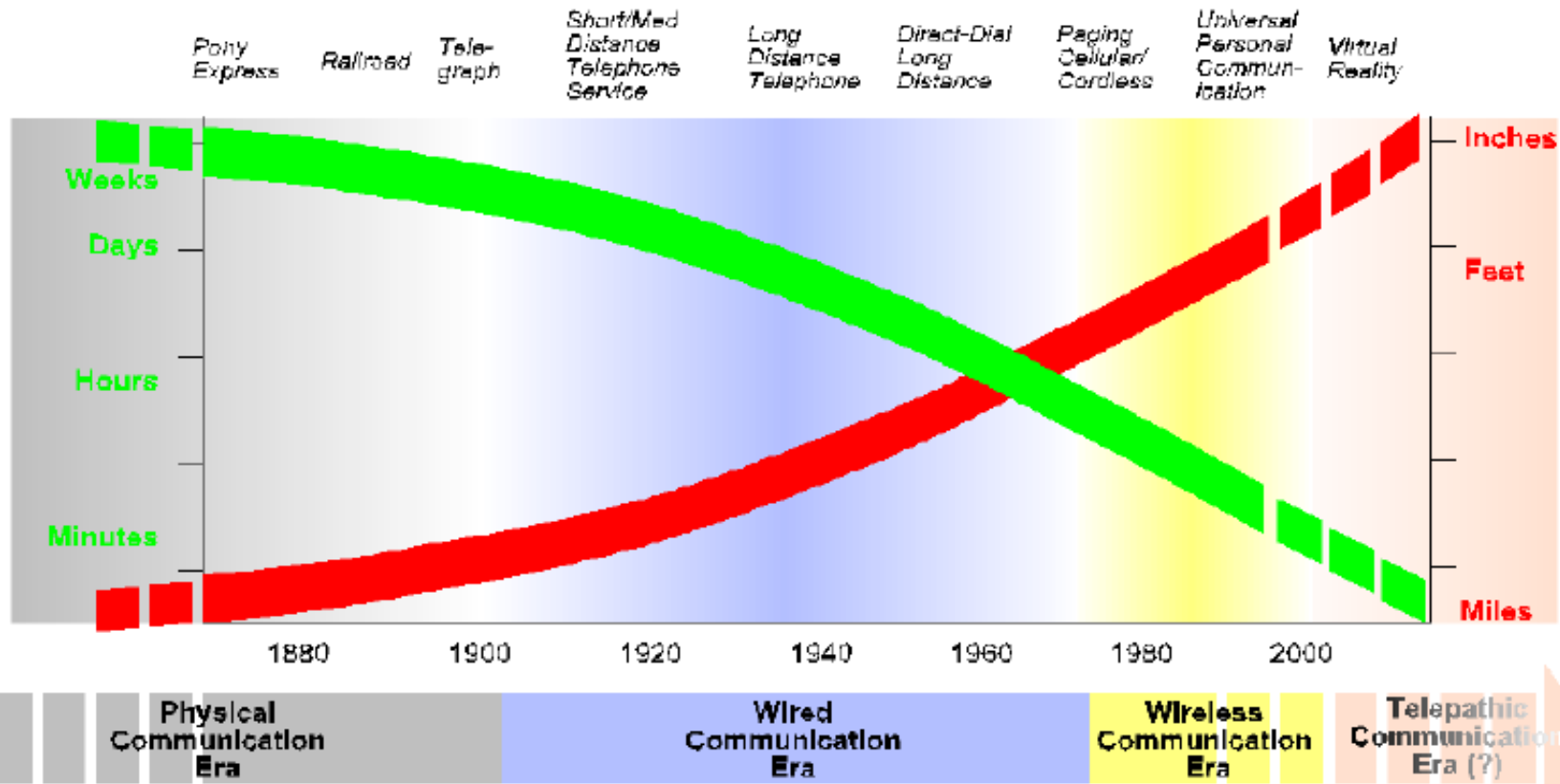

Each communication technology advance has shortened the useful life of information and increased the need to obtain new information more rapidly regardless of the situation or location...



Mobility Evolution – 1G

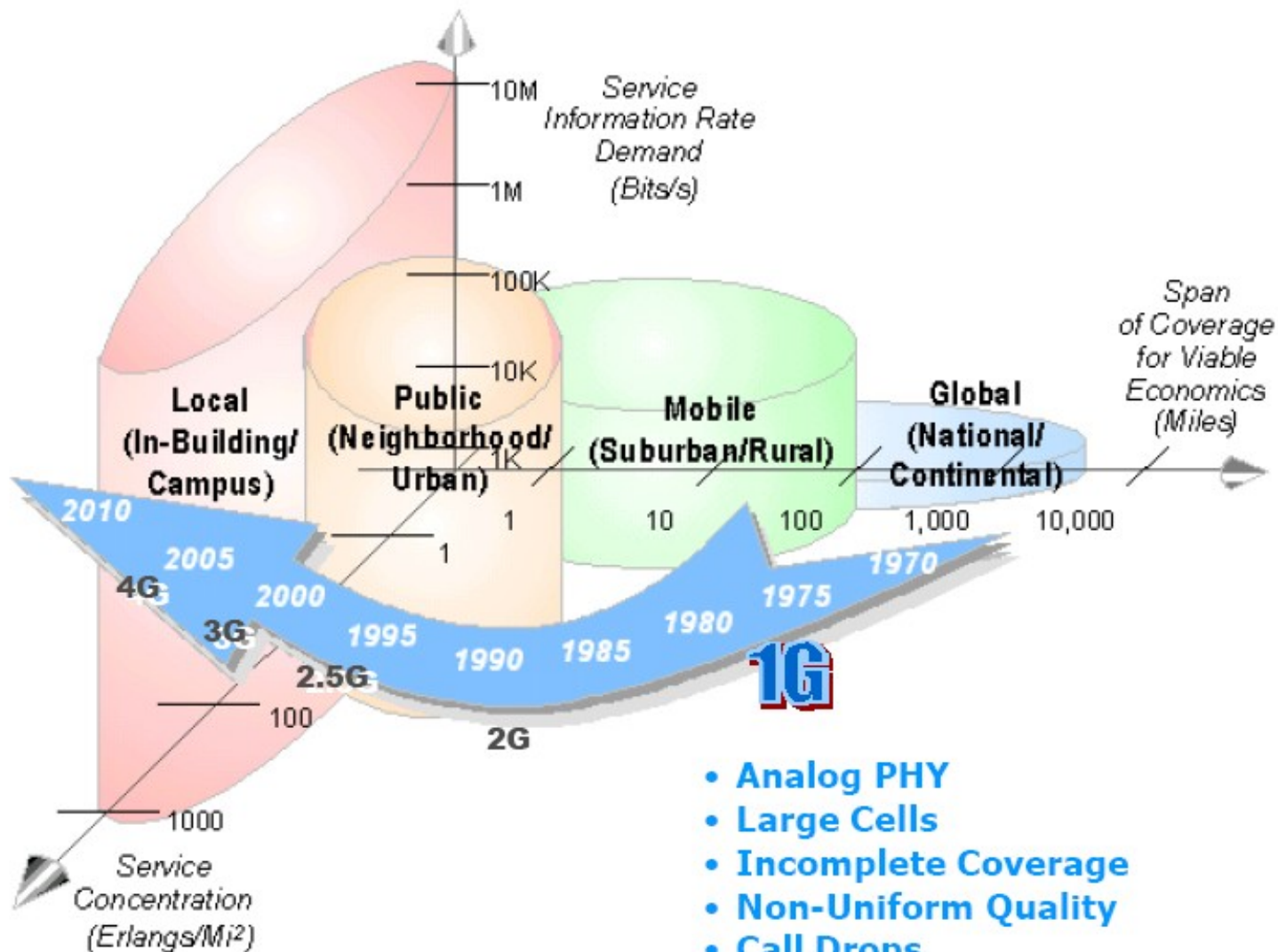



Device Presence: Unlocking the Value of “Chip Radios”

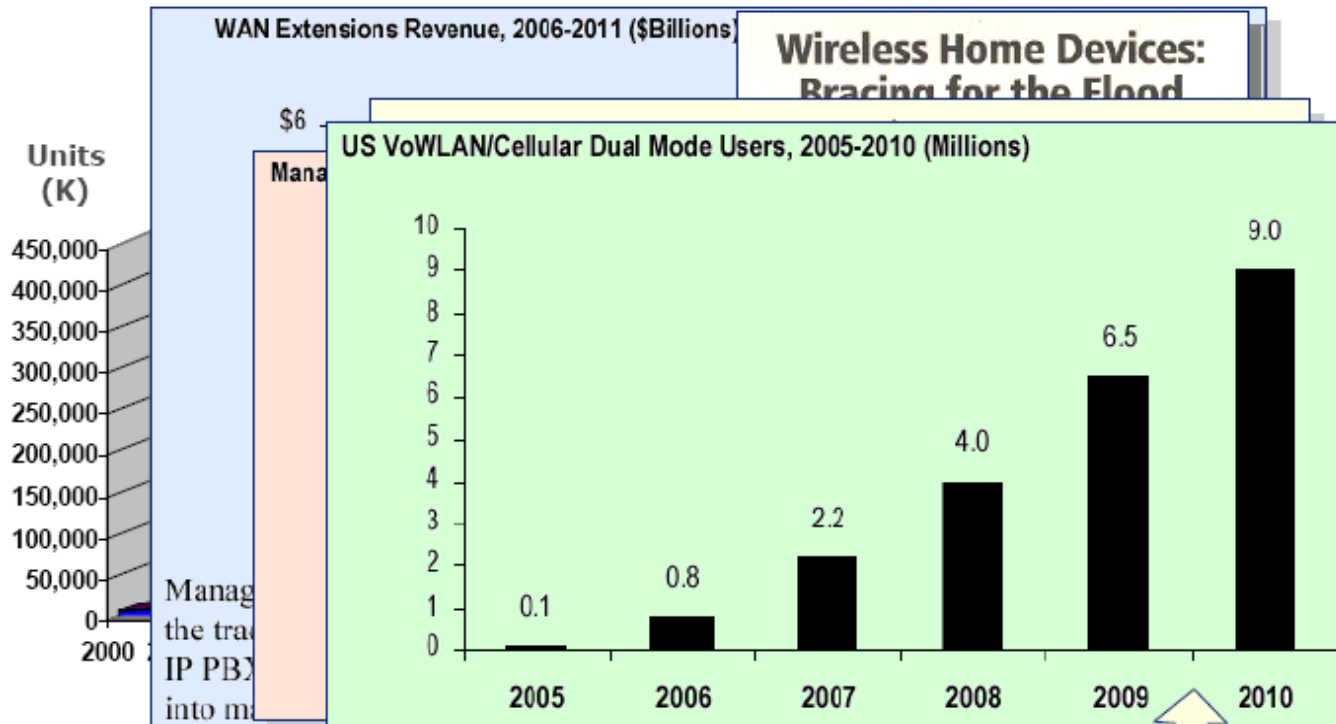

- 100K+ hotspots worldwide, CAGR of 45% (JiWire)
- 90% of airports to offer Wi-Fi by 2008 (Airports Council International)
- 269M broadband homes worldwide in 2009 (IDC)
- 72% of companies to deploy Voice over Wi-Fi by 2009 (Infonetics)
- 100 million consumer mobile VOIP users in 2011
- The PC industry will ship more than two times as many mobile VOIP devices per year as the Telecom industry in 2011.

Fast Growth of Wireless Use



- Social networking (e.g., micro-blogging)
- Multimedia downloads (e.g., Hulu, YouTube)
- Gaming (Xbox Live)
- 2D video conferencing
- File sharing & collaboration
- Cloud storage

Next generation applications

- Immersive video conferencing
- 3D Telemedicine
- Virtual & Augmented reality
- Assistive Technology

○ Rapid increase in the multimedia mobile Internet traffic

Fast Growth of Wireless Use (2/2)



- Video driving rapid growth in mobile Internet traffic
- Expected to rise 66x by 2013 (Cisco Visual Networking Index-Mobile Data traffic Forecast)

Energy constrains

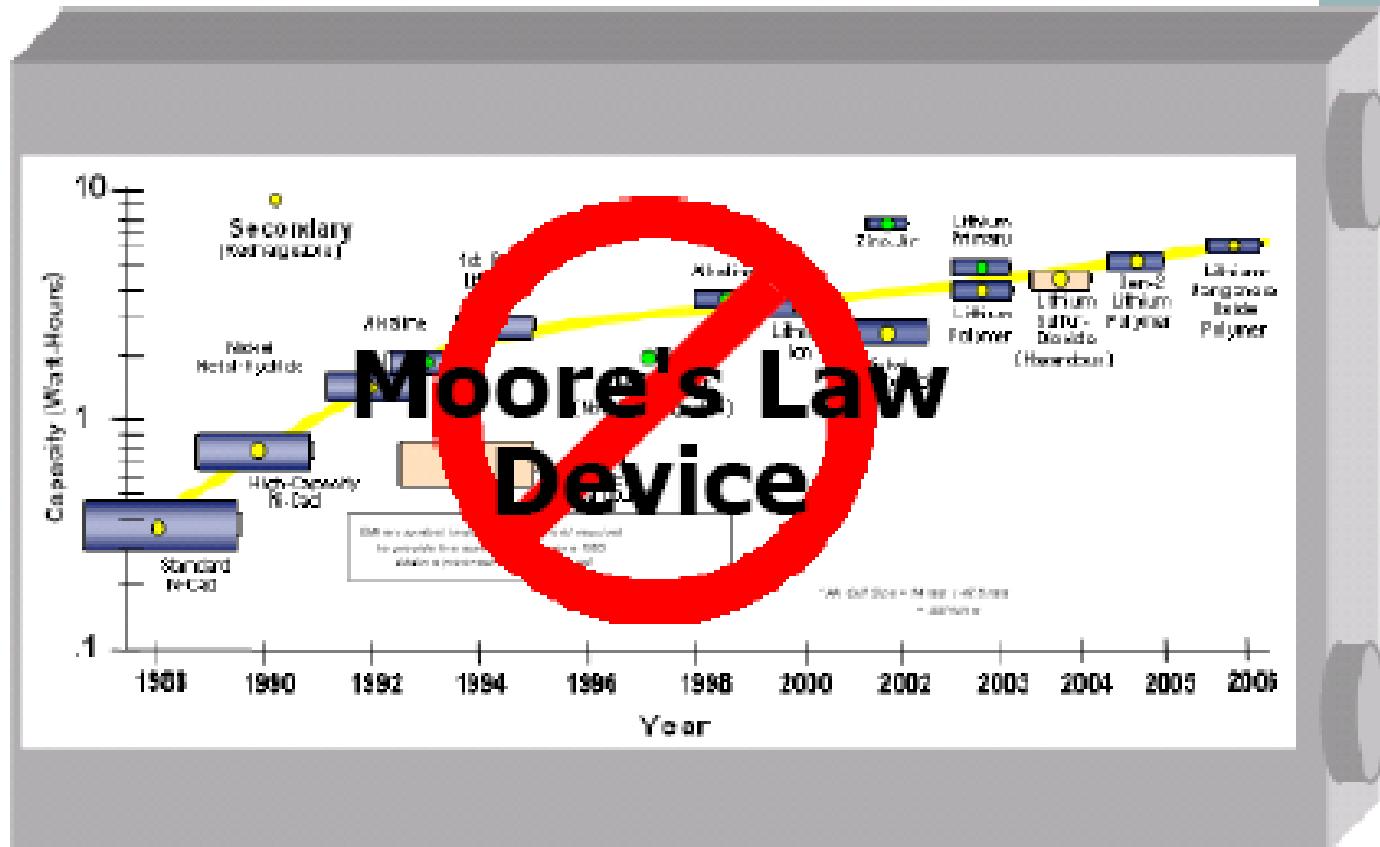

Rechargeable Battery Capacity Trends

Wireless Networks



- Are ***extremely complex***
- Have been used for **many different purposes**
- Have their own distinct characteristics due to ***radio propagation*** characteristics & ***mobility***
 - wireless channels can be **highly asymmetric** & **time varying**

Wireless Networks & Mobile Computing



Lecture on *Physical Layer*

Prof. Maria Papadopouli

University of Crete

ICS-FORTH

<http://www.ics.forth.gr/mobile>

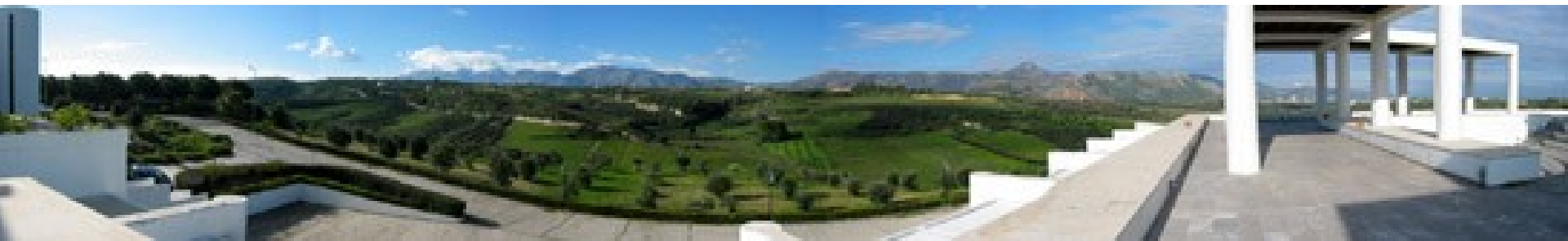

From Signals to Packets



Analog Signal

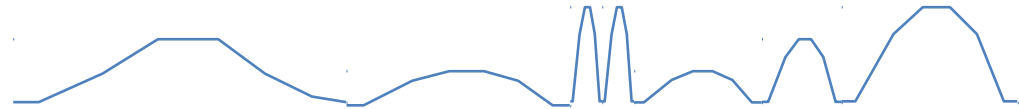

“Digital” Signal



Bit Stream

0 0 1 0 1 1 1 0 0 0 1

Packets

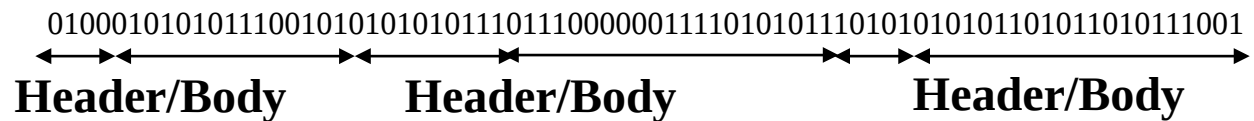

Packet Transmission

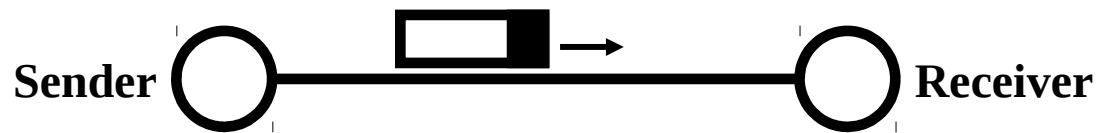

Note: there is no co-relation between the above figures. Each one is independent from the others.

Μοντέλο Τηλεπικοινωνιακών Συστημάτων



{από τη σκοπιά των σημάτων}

- Ο δίαυλος επικοινωνίας μπορεί να είναι μια γραμμή μεταφορά (π.χ. τηλεφωνία, Ethernet), μια οπτική ίνα ή απλά ο ελεύθερος χώρος (όπου το σήματα εκπέμπεται σαν ηλεκτρομαγνητικό κύμα).

Μετάδοση Σήματος



- Κατά τη **διάδοση του διαύλου το μεταδιδόμενο σήμα παραμορφώνεται** λόγω **μη γραμμικότητων και/ή ατελειών** στην απόκριση συχνότητας του διαύλου
- Άλλες πηγές υποβάθμισης είναι ο **θόρυβος και οι παρεμβολές** που συλλέγονται από το σήματα κατά τη διάρκεια της μετάδοσης μέσω του διαύλου.
- Ο πομπός και ο δέκτης σχεδιάζονται ώστε να **ελαχιστοποιούν τα αποτελέσματα του θορύβου και της παραμόρφωσης στη ποιότητα λήψης**
- Αναδημιουργώντας το αρχικό σήμα, χρησιμοποιώντας τη διαδικασία της **από-διαμόρφωσης (demodulation)**
- Κύριοι πόροι (main resources): **ισχύς εκπομπής** (transmission power) & **εύρος ζώνης** (channel bandwidth)

Βασικοί Όροι στα Σήματα (Basic terms)



- Σύστημα: φυσική διάταξη που παράγει ένα σήμα εξόδου σε απόκριση ενός σήματος εισόδου

Physical system that produces an output signal as a response to an input signal/excitation

- Σήμα εισόδου (input): **διέγερση** (excitation)
- Σήμα εξόδου (output): **απόκριση** (response)

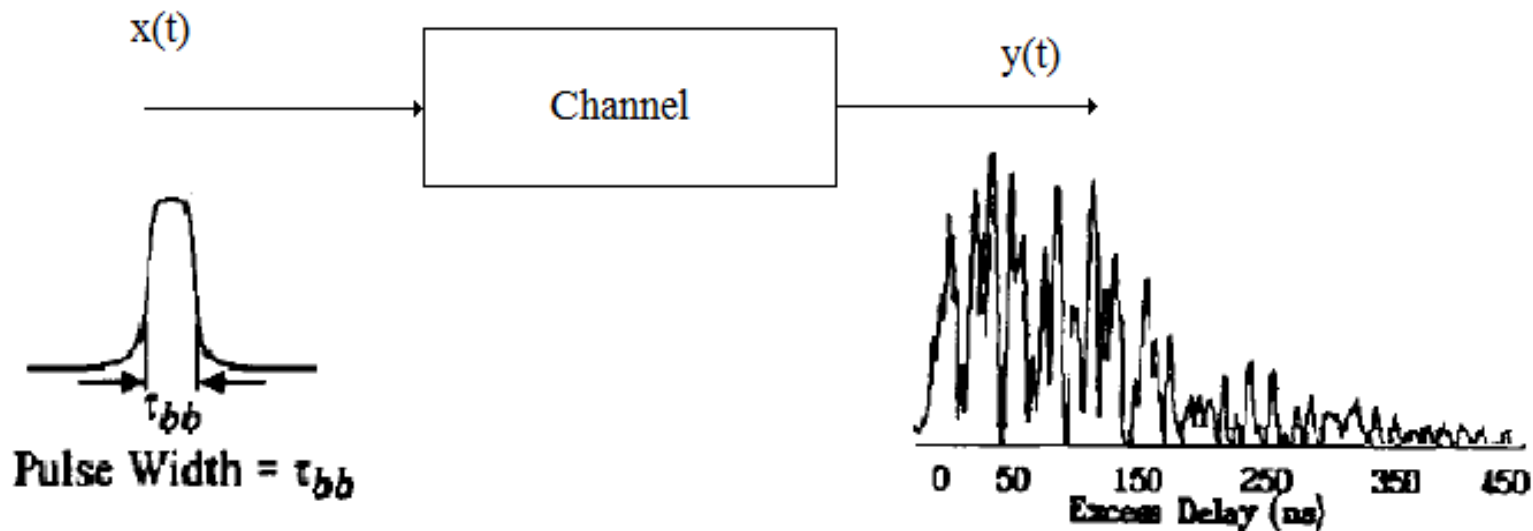

Channel Model



- The received signal can be modeled by a magnitude and phase, which represent the signal attenuation and delay from sender antenna to receiver antenna,

given a certain frequency,
where the communication takes place

- Devices use the transmission of a well-known training signal for the estimation of various parameters

Βασικοί Όροι στα Σήματα



- Σε γραμμικά συστήματα ισχύει η **αρχή της υπέρθεσης** (superimposition):
Η **απόκριση ενός γραμμικού συστήματος σε ένα αριθμό διεγέρσεων** τα οποία εφαρμόζονται ταυτόχρονα είναι **ίση με το άθροισμα των αποκρίσεων του συστήματος, όταν κάθε μια από αυτές τις διεγέρσεις εφαρμόζεται ξεχωριστά**
- Φίλτρο: διάταξη επιλογής συχνότητας που χρησιμοποιείται για να περιορίσει το φάσμα ενός σήματος σε μια ζώνη συχνοτήτων
- Δίαυλος: μέσο μετάδοσης που συνδέει τον πομπό με τον δέκτη του συστήματος επικοινωνίας
- Περιγραφή στο πεδίο χρόνου ή συχνότητας

Internet - Network Layers -(TCP/IP stack)

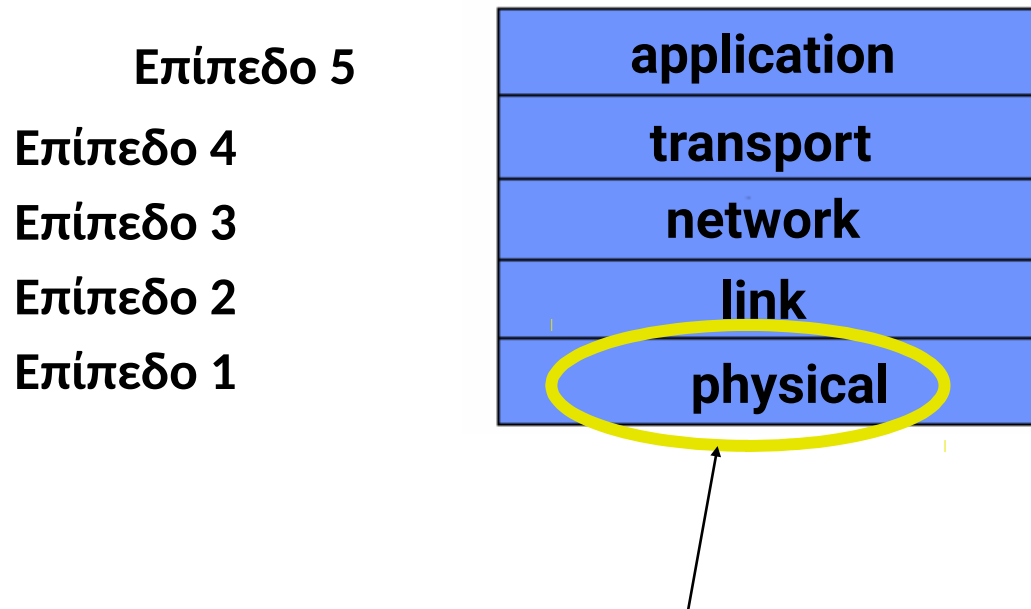

Transmission of sequence of bits & signals across a link

□ Signal: “superimposition” of electromagnetic waves

Spectrum

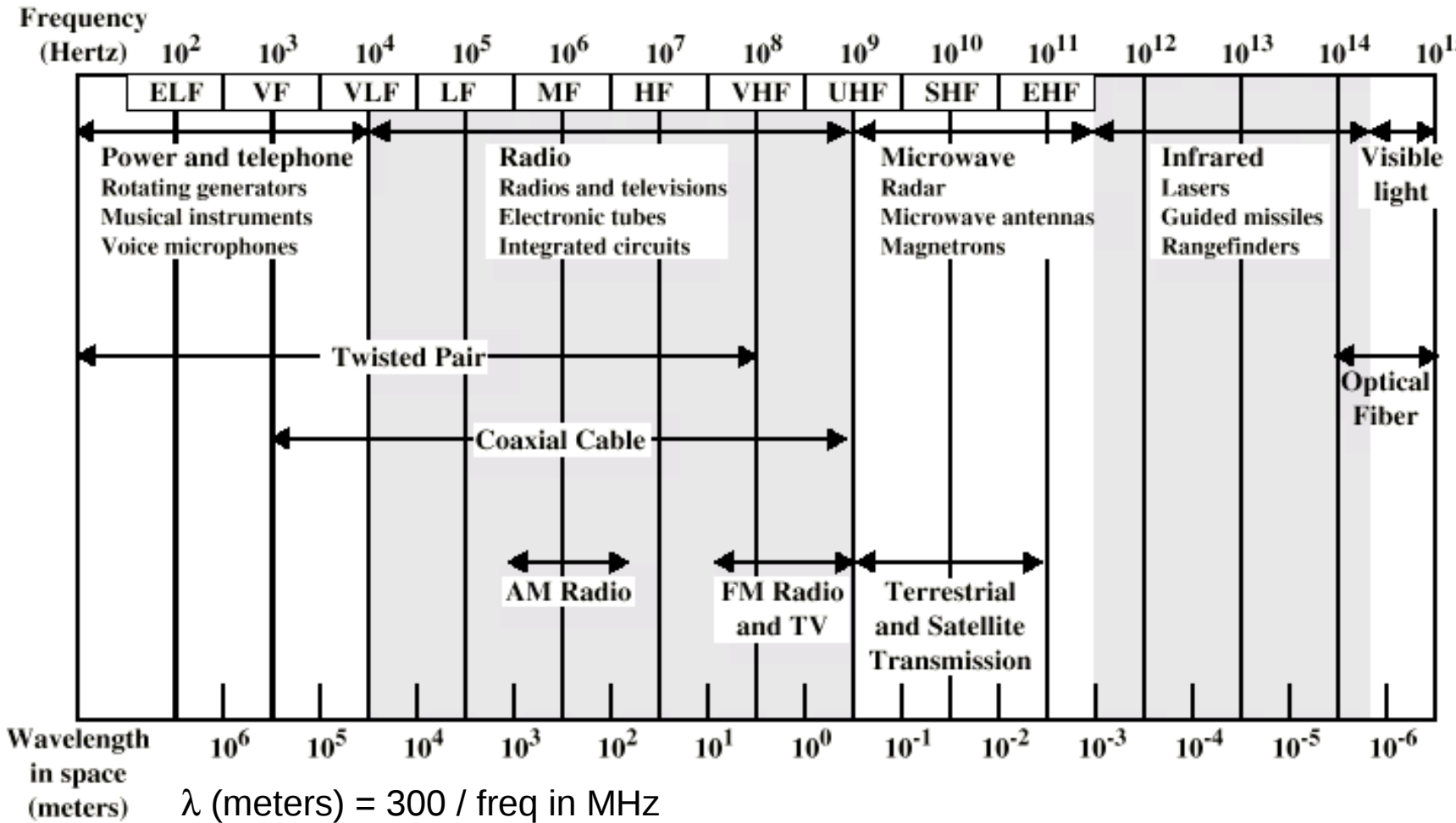

ELF = Extremely low frequency
 VF = Voice frequency
 VLF = Very low frequency
 LF = Low frequency

MF = Medium frequency
 HF = High frequency
 VHF = Very high frequency

UHF = Ultrahigh frequency
 SHF = Superhigh frequency
 EHF = Extremely high frequency

Transmitter & Radio Channel



Electromagnetic Waveforms



Two important properties

- **Propagate**

They travel in the space from the sender to a receiver

- **Transfer energy**

This energy can be used for data transmission

Φυσικό επίπεδο



- Χειρίζεται τη **μεταφορά της ακολουθίας των bits** ξεχωριστά κατά μήκος της ζεύξης

Η ζεύξη παραδίδει **bits αφού πρώτα τα μετατρέψει σε σήματα** τα οποία διαδίδονται μέσω ενός καναλιού

σ Τα bits στέλνονται **διαδίδοντας ηλεκτρομαγνητικά κύματα** κατά μήκους του φυσικού μέσου, πχ

- Επίγειο φάσμα ραδιοσυχνοτήτων
- Δορυφορικό φάσμα ραδιοσυχνοτήτων

Σήμα καλείται η **υπέρθυση ηλεκτρομαγνητικών κυμμάτων**



Ηλεκτρομαγνητικά κύματα

Έχουν δύο σημαντικές ιδιότητες:

1. Διαδίδονται

□ Μετακινούνται δηλαδή απο το ένα μέρος στο άλλο, όπως από ένα πομπό σε ένα δέκτη

2. Περιέχουν ενέργεια η οποία μπορεί να χρησιμοποιηθεί για τη μεταφορά μηνυμάτων

Ηλεκτρομαγνητικά κύματα (συνέχεια)



- Το Ηλεκτρομαγνητικό κύμα μπορεί να θεωρηθεί ως μια ροή φωτονίων
- Φωτόνιο: **μικρή ριπή ηλεκτρομαγνητικής ενέργειας**

Η ενέργεια μεταφέρεται από φωτόνια

- Το φαινόμενο διάδοσης προκαλείται από τις **αλληλεπιδράσεις ενός ταλαντούμενου ηλεκτρικού πεδίου και ενός ταλαντούμενου μαγνητικού πεδίου τα οποία ωθούν το ένα το άλλο στο κενό ή σε ένα άλλο μέσο διάδοσης**

Βασικές αρχές



Ένα μεταβαλλόμενο μαγνητικό πεδίο παράγει ένα μεταβαλλόμενο ηλεκτρικό πεδίο (*Faraday*)

Σε ένα **ηλεκτρομαγνητικό κύμα**, ένα μεταβαλλόμενο πεδίο επάγει ένα **μεταβαλλόμενο ηλεκτρικό πεδίο**, το οποίο με τη σειρά του δημιουργεί ένα **μεταβαλλόμενο μαγνητικό πεδίο** κ.ο.κ ... προκαλώντας έτσι τη **διάδοση του κύματος** (Maxwell)

Ηλεκτρομαγνητικό κύμα (συνέχεια)

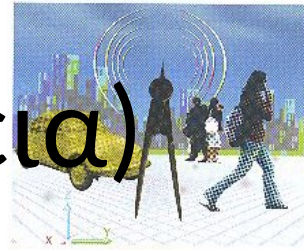

- Περιγράφεται από τη **συχνότητα**: αριθμός ταλαντώσεων των ηλεκτρικών και μαγνητικών πεδίων στην μονάδα του χρόνου
 - 1Hertz αντιστοιχεί σε μια πλήρη ταλάντωση ανά δευτερόλεπτο
 - και το **μήκος κύματος**: λόγος ταχύτητας διάδοσης προς **συχνότητα**
- Τα δίκτυα επικοινωνιών μεταδίδουν πληροφορία μέσω ηλεκτρομαγνητικών κυμάτων



Βασικά στοιχεία ηλεκτρικού ρεύματος

- Η **ροή φορτίου** (flow charge) ονομάζεται **ηλεκτρικό ρεύμα** (electric current) και είναι ο ρυθμός με τον οποίο τα ηλεκτρικά φορτία διέρχονται διαμέσου ενός αγωγού (*conductive material*)
- Τα φορτισμένα σωματίδια μπορούν να είναι είτε θετικά είτε αρνητικά
- Για τη ροή φορτίου, απαιτείται μία ώθηση (μία δύναμη) η οποία παρέχεται από την **τάση** ή **διαφορά δυναμικού (potential difference)**
- Το φορτίο (charge) κινείται από το υψηλό δυναμικό (περιοχή υψηλής δυναμικής ενέργειας) προς το χαμηλό δυναμικό (περιοχή χαμηλής δυναμικής ενέργειας)
- ⊖ Αν υπάρχει **διαφορά δυναμικού** μεταξύ δύο περιοχών και εμείς τις συνδέσουμε (αγωγή), **θα υπάρξει ροή φορτίου**
- ⊖ Το **φορτίο συνεχίζει να κινείται** μέχρι η δύναμη που ασκείται πάνω του να **μειωθεί σε κάποια ελάχιστη τιμή ή έως ότου το δυναμικό εξισωθεί**

Βασικά στοιχεία ηλεκτρικής τάσης



- Η τάση θα έπρεπε να καλείται ορθότερα «διαφορά δυναμικού»
- Είναι στην πραγματικότητα η **ηλεκτρεγερτική δύναμη** (emf) (η κινητήριος δύναμη των ηλεκτρονίων στον ηλεκτρισμό)
- Η **διαφορά δυναμικού** είναι υπεύθυνη για την άπωση και την έλξη των ηλεκτρονίων ή για το **ηλεκτρικό ρεύμα διαμέσου ενός κυκλώματος**
- Μία κινητήριος δύναμη ηλεκτρονίων επίσης υπάρχει μεταξύ δύο αντικειμένων όποτε υπάρχει μία διαφορά στον **αριθμό των ελεύθερων ηλεκτρονίων ανά μονάδα όγκου** του αντικειμένου.
- Όταν δύο αντικείμενα, που είναι αρνητικά φορτισμένα, συνδεθούν αγώγιμα μεταξύ τους, το ηλεκτρικό ρεύμα θα έχει φορά από το περισσότερο αρνητικά φορτισμένο αντικείμενο προς το λιγότερο αρνητικά φορτισμένο
- Ροή ηλεκτρικού ρεύματος θα υπάρξει επίσης από ένα λιγότερο θετικά φορτισμένο αντικείμενο προς ένα περισσότερο θετικά φορτισμένο αντικείμενο, εφόσον τα δύο αντικείμενα συνδεθούν αγώγιμα μεταξύ τους

Φυσικό επίπεδο



- Χειρίζεται τη **μεταφορά της ακολουθίας των bits** ξεχωριστά κατά μήκος της ζεύξης

Η ζεύξη παραδίδει **bits αφού πρώτα τα μετατρέψει σε σήματα** τα οποία διαδίδονται μέσω ενός καναλιού

⊆ Σήμα καλείται η **υπέρθεση ηλεκτρομαγνητικών κυμάτων**

σ̄ Τα bits στέλνονται **διαδίδοντας ηλεκτρομαγνητικά κύματα** ή **οπτικούς παλμούς** κατα μήκος του φυσικού μέσου

- Συνεστραμμένο χάλκινο καλώδιο (twisted pair copper wire)
- Ομοαξονικό καλώδιο (coaxial cable)
- Επίγειο φάσμα ραδιοσυχνοτήτων
- Δορυφορικό φάσμα ραδιοσυχνοτήτων



Ηλεκτρομαγνητικά κύματα

Έχουν δύο σημαντικές ιδιότητες:

1. Διαδίδονται

□ Μετακινούνται δηλαδή απο το ένα μέρος στο άλλο, όπως από ένα πομπό σε ένα δέκτη

2. Περιέχουν ενέργεια η οποία μπορεί να χρησιμοποιηθεί για τη μεταφορά μηνυμάτων

Ηλεκτρομαγνητικά κύματα (συνέχεια)



- Το Ηλεκτρομαγνητικό κύμα μπορεί να θεωρηθεί ως μια ροή φωτονίων
- Φωτόνιο: **μικρή ριπή ηλεκτρομαγνητικής ενέργειας**

Η ενέργεια μεταφέρεται από φωτόνια

- Το φαινόμενο διάδοσης προκαλείται από τις **αλληλεπιδράσεις ενός ταλαντούμενου ηλεκτρικού πεδίου και ενός ταλαντούμενου μαγνητικού πεδίου τα οποία ωθούν το ένα το άλλο στο κενό ή σε ένα άλλο μέσο διάδοσης**

Βασικές αρχές



Ένα μεταβαλλόμενο μαγνητικό πεδίο παράγει ένα μεταβαλλόμενο ηλεκτρικό πεδίο (*Faraday*)

Σε ένα **ηλεκτρομαγνητικό κύμα**, ένα μεταβαλλόμενο πεδίο επάγει ένα **μεταβαλλόμενο ηλεκτρικό πεδίο**, το οποίο με τη σειρά του δημιουργεί ένα **μεταβαλλόμενο μαγνητικό πεδίο** κ.ο.κ ... προκαλώντας έτσι τη **διάδοση του κύματος** (Maxwell)

Ηλεκτρομαγνητικό κύμα (συνέχεια)



- Περιγράφεται από τη **συχνότητα**: αριθμός ταλαντώσεων των ηλεκτρικών και μαγνητικών πεδίων στην μονάδα του χρόνου
 - ⊖ 1Hertz αντιστοιχεί σε μια πλήρη ταλάντωση ανά δευτερόλεπτο
- και το **μήκος κύματος**: λόγος ταχύτητας διάδοσης προς συχνότητα
- Τα δίκτυα επικοινωνιών μεταδίδουν πληροφορία μέσω ηλεκτρομαγνητικών κυμάτων

Τα **ηλεκτρόνια** στα σύρματα ή στο καλώδιο μίας γραμμής χαλκού **αλληλοεπιδρούν με το ηλεκτρομαγνητικό κύμα και το οδηγούν**

Βασικά στοιχεία ηλεκτρικού ρεύματος



- Η **ροή φορτίου** ονομάζεται **ηλεκτρικό ρεύμα** και είναι ο ρυθμός με τον οποίο τα ηλεκτρικά φορτία διέρχονται διαμέσου ενός αγωγού
- Τα φορτισμένα σωματίδια μπορούν να είναι είτε θετικά είτε αρνητικά
- Για τη ροή φορτίου, απαιτείται μία ώθηση (μία δύναμη) η οποία παρέχεται από την **τάση** ή **διαφορά δυναμικού**
- Το φορτίο κινείται από το υψηλό δυναμικό (περιοχή υψηλής δυναμικής ενέργειας) προς το χαμηλό δυναμικό (περιοχή χαμηλής δυναμικής ενέργειας)
- Αν υπάρχει **διαφορά δυναμικού** μεταξύ δύο περιοχών και εμείς τις συνδέσουμε (αγωγίμα), **θα υπάρξει ροή φορτίου**
- Το **φορτίο συνεχίζει να κινείται** μέχρι η δύναμη που ασκείται πάνω του να **μειωθεί σε κάποια ελάχιστη τιμή ή έως ότου το δυναμικό εξισωθεί**

Βασικά στοιχεία ηλεκτρικής τάσης



- Η τάση θα έπρεπε να καλείται ορθότερα «διαφορά δυναμικού»
- Είναι στην πραγματικότητα η ηλεκτρεγερτική δύναμη (emf) (η κινητήριος δύναμη των ηλεκτρονίων στον ηλεκτρισμό)
- Η **διαφορά δυναμικού** είναι υπεύθυνη για την άπωση και την έλξη των ηλεκτρονίων ή για το **ηλεκτρικό ρεύμα διαμέσου ενός κυκλώματος**



Βασικά στοιχεία ηλεκτρικής τάσης

- Μία κινητήριος δύναμη ηλεκτρονίων επίσης υπάρχει μεταξύ δύο αντικειμένων όποτε υπάρχει μία διαφορά στον **αριθμό των ελεύθερων ηλεκτρονίων ανά μονάδα όγκου** του αντικειμένου.
- Όταν δύο αντικείμενα, που είναι αρνητικά φορτισμένα, συνδεθούν αγώγιμα μεταξύ τους, το ηλεκτρικό ρεύμα θα έχει φορά από το περισσότερο αρνητικά φορτισμένο αντικείμενο προς το λιγότερο αρνητικά φορτισμένο
- Ροή ηλεκτρικού ρεύματος θα υπάρξει επίσης από ένα λιγότερο θετικά φορτισμένο αντικείμενο προς ένα περισσότερο θετικά φορτισμένο αντικείμενο, εφόσον τα δύο αντικείμενα συνδεθούν αγώγιμα μεταξύ τους

Βασικά στοιχεία ηλεκτρικής τάσης (συνέχεια)



- ✎ Το ηλεκτροστατικό πεδίο, δηλαδή η τάση των ηλεκτρονίων να προσπαθούν να φτάσουν ένα θετικό φορτίο ή να προέρχονται από πιο υψηλό αρνητικό φορτίο είναι η κινητήριος δύναμη των ηλεκτρονίων ή αλλιώς τάση
 - Εκφράζεται σε μονάδες που ονομάζονται **volts**, σύντμηση του voltage
- ⊖ Ως ένα **volt** ορίζεται η **πίεση που απαιτείται για τη διέλευση ρεύματος ενός ampere διαμέσου μίας αντίστασης ενός ohm**

Έννοιες πεδίου χρόνου: Αναλογικά & ψηφιακά σήματα



- **Μέγιστο εύρος (A)** - Μέγιστη τιμή ή δύναμη του σήματος με την πάροδο του χρόνου. Συνήθως μετριέται σε volts
- **Συχνότητα (f)**: Ρυθμός (rate), σε cycles/sec ή Hertz (Hz) στους οποίους το σήμα επαναλαμβάνεται
- **Φάση (φ)** - Μέτρο της σχετικής θέσης στο χρόνο εντός μίας περιόδου του σήματος

≡ γενικό κύμα ημιτόνου $s(t) = A \sin(2\pi ft + \varphi)$

- Οποιοδήποτε ηλεκτρομαγνητικό σήμα μπορεί να αποδειχθεί ότι αποτελείται από μια συλλογή περιοδικών αναλογικών σημάτων (κύματα ημιτόνου) σε διαφορετικά εύρη, συχνότητες και φάσεις

$$x(t) = \sum_{k=1}^N A_k \cos(\omega_0 t + \phi_k)$$

Βασικά στοιχεία ηλεκτρικής τάσης (συνέχεια)



- ✎ Το ηλεκτροστατικό πεδίο, δηλαδή η τάση των ηλεκτρονίων να προσπαθούν να φτάσουν ένα θετικό φορτίο ή να προέρχονται από πιο υψηλό αρνητικό φορτίο είναι η κινητήριος δύναμη των ηλεκτρονίων ή αλλιώς τάση
 - Εκφράζεται σε μονάδες που ονομάζονται **volts**, σύντμηση του voltage
- ⊖ Ως ένα **volt** ορίζεται η **πίεση που απαιτείται για τη διέλευση ρεύματος ενός ampere διαμέσου μίας αντίστασης ενός ohm**

Έννοιες πεδίου χρόνου: Αναλογικά & ψηφιακά σήματα



- **Μέγιστο εύρος (A)** - Μέγιστη τιμή ή δύναμη του σήματος με την πάροδο του χρόνου. Συνήθως μετριέται σε volts
- **Συχνότητα (f)**: Ρυθμός (rate), σε cycles/sec ή Hertz (Hz) στους οποίους το σήμα επαναλαμβάνεται
- **Φάση (φ)** - Μέτρο της σχετικής θέσης στο χρόνο εντός μίας περιόδου του σήματος

≡ γενικό κύμα ημιτόνου $s(t) = A \sin(2\pi ft + \varphi)$

- Οποιοδήποτε ηλεκτρομαγνητικό σήμα μπορεί να αποδειχθεί ότι αποτελείται από μια συλλογή περιοδικών αναλογικών σημάτων (κύματα ημιτόνου) σε διαφορετικά εύρη, συχνότητες και φάσεις

$$x(t) = \sum_{k=1}^N A_k \cos(\omega_0 t + \phi_k)$$

Antenna (1/2)



- Made of conducting material
- Radio waves hitting an antenna cause **electrons to flow in the conductor** and **create current**
- Likewise, **applying a current** to an antenna creates an **electric field** around the antenna
- As the current of the antenna changes, so does **the electric field**
- A **changing electric field causes a magnetic field**, and the wave is off ...

Antenna (2/2)



- **Antenna gain**
the extent to which it **enhances the signal** in its preferred direction
- **Isotropic antenna**
radiates power with unit gain **uniformly in all directions**
- Measured in **dB_i**: decibels relative to an isotropic radiator

What is dB?



Express a **ratio** in logarithmic scale based on transformation

The decibel offers a number of advantages, e.g., ability to

- conveniently represent very large or small numbers, and
- carry out multiplication of ratios by simple addition and subtraction.

Example:

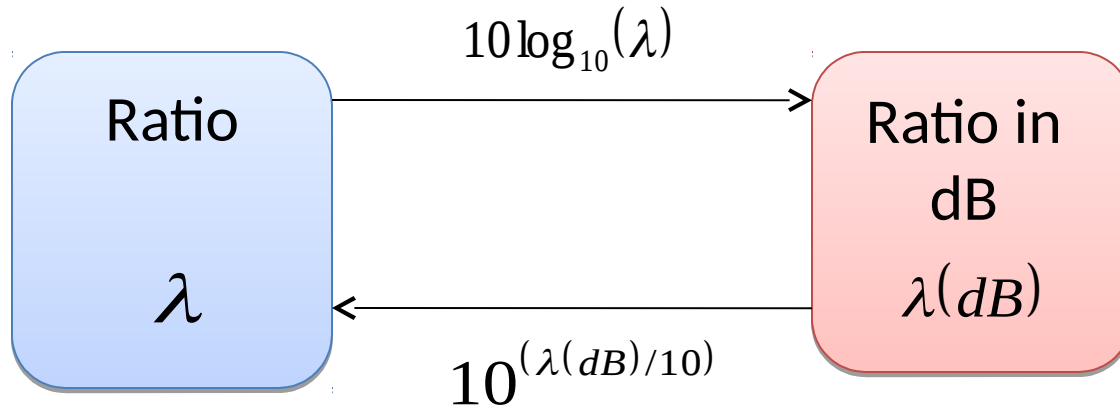

$$SINR = \frac{S}{N + I} = \frac{10^{-5} \text{ mW}}{1.2 \cdot 10^{-8} \text{ mW} + 2 \cdot 10^{-8} \text{ mW}} = 312,5 \Leftrightarrow$$

$$SINR(dB) = 10 \log_{10}(312.5) = 24.95 \text{ dB}$$

What is dBm?



Express transmitted/received **power** in logarithmic scale based on transformation:

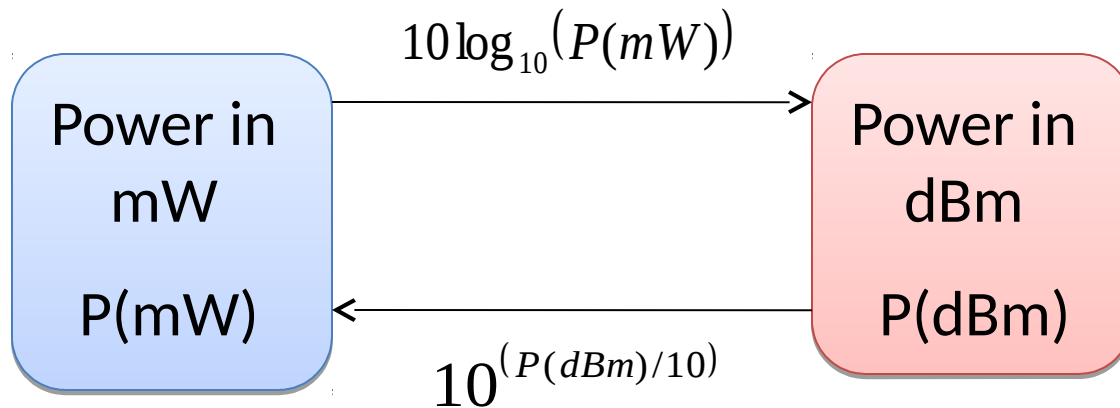

Example:

$$P = 2 \text{ mW} \Leftrightarrow P = 3.0103 \text{ dBm}$$



dBm (sometimes **dBmW**) is an abbreviation for the power ratio in decibels (dB) of the **measured power** referenced to **one milliwatt** (mW).

Conversion of a stream of bits into signal

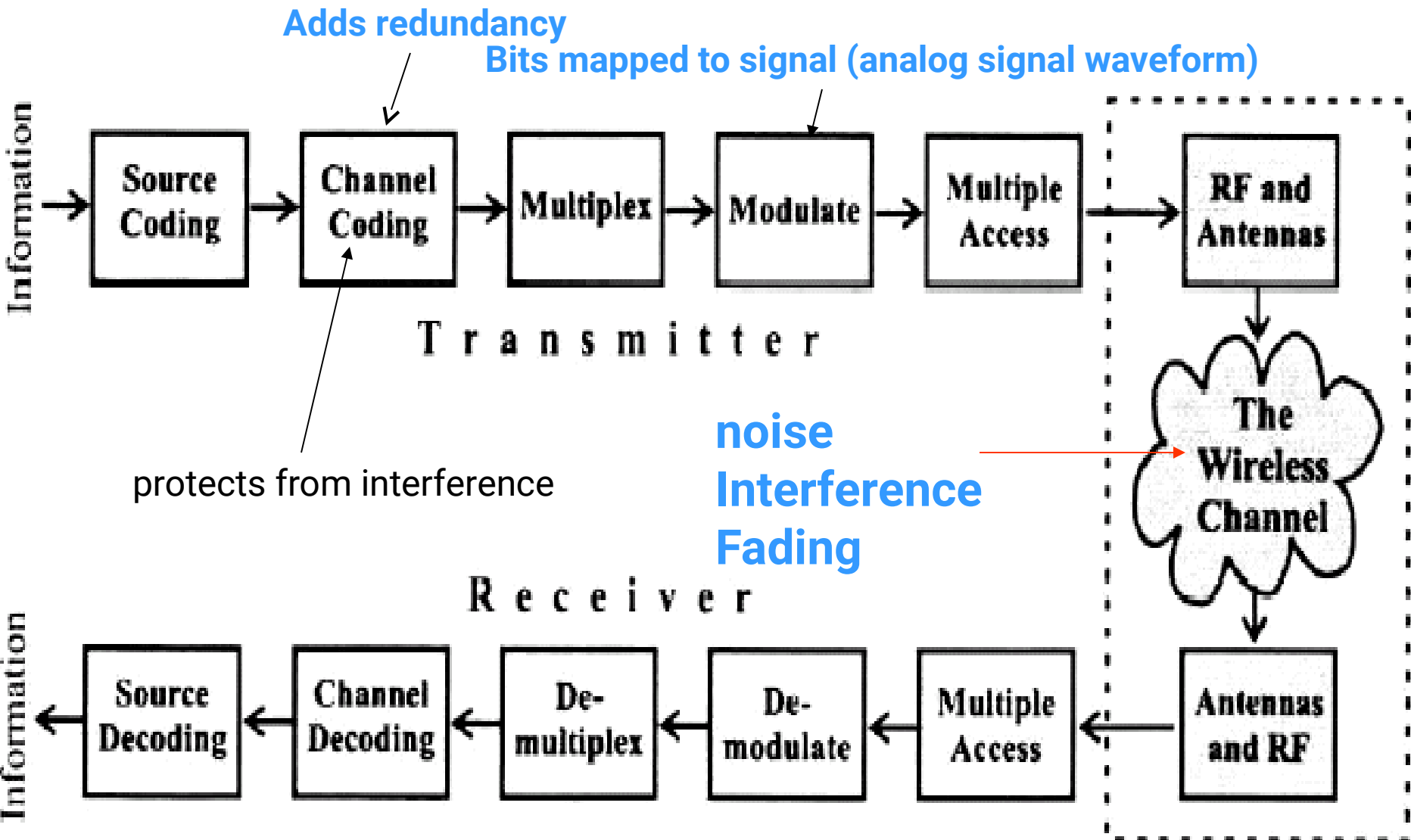



Electromagnetic-Field Equations

In the far field, the *electric & magnetic fields* at any given location are:

- **perpendicular** to both each other & to the direction of propagation from the antenna
- **proportional to each other** (so it is sufficient to know only one of them)

In response to a **transmitted sinusoid $\cos(2\pi ft)$** , the electric far field at **time t** can be expressed as:

$$E(f, t(r, \theta, \psi)) = a_s(\theta, \psi, f) * \cos(2\pi f(t - r/c)) / r$$

Point **$u(r, \theta, \psi)$** in space @ which the electric field is being measured

Distance **r** from the transmit antenna to point **u**

Radiation pattern of the sending antenna @ **frequency f** & **direction (θ, ψ)**



Wavelength of Electromagnetic Radiation

- **Frequency f**
- **Wavelength λ**

$$\lambda = c/f$$

where c is the **speed of light** $c=3 \times 10^8$ m/s

Example: cellular communication around 0.9GHz, 1.9GHz, and 5.8GHz
⇒ wavelength is a fraction of a meter

⇒

To calculate the electromagnetic field equations at a receiver:
the locations of receiver, transmitter & obstructions need to be known with sub-meter accuracy

Signals



- **Amplitude (A)** – Maximum value, peak deviation of the function
- **Frequency (f)**: Rate, *number of oscillations in a unit time interval*, in cycles/sec ḡ Hertz (Hz)
- **Phase(φ)** – Specifies the relative position in its cycle the oscillation begins
general wave formula $s(t) = A \sin(2\pi f t + \phi)$

□ Any waveform can be presented as a **collection** of periodic analog signals (cosines) **with different amplitudes, phases, and frequencies**

$$x(t) = \sum_{k=1}^N A_k \cos(\omega_0 t + \phi_k)$$

Χρήση των ημιτονοειδή συναρτήσεων



Χρησιμοποιούμε ημιτονοειδής συναρτήσεις λόγω της δυνατότητας **επιλογής της κεντρικής συχνότητας** που μπορούμε να μεταδώσουμε, και λόγω των **φασματικών χαρακτηριστικών** που έχει αυτή η συνάρτηση.

Στο **πεδίο της συχνότητας** μια **ημιτονοειδής συνάρτηση** περιγράφεται από ένα **Dirac**.

Αλλάζοντας τη διάρκεια συμβόλου (δηλ. πόσο χρόνο χρειάζεται να μεταδώσουμε ένα σύμβολο), μπορούμε να αλλάξουμε το bandwidth.

Wave “aggregation” by superposition

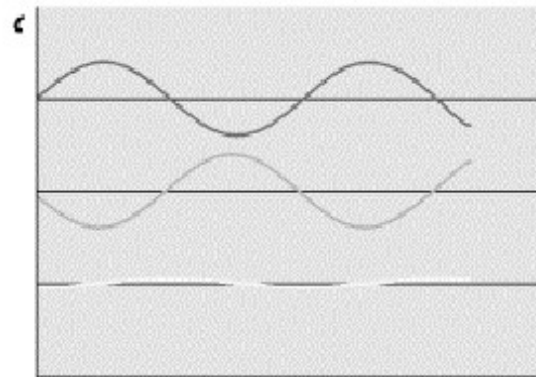
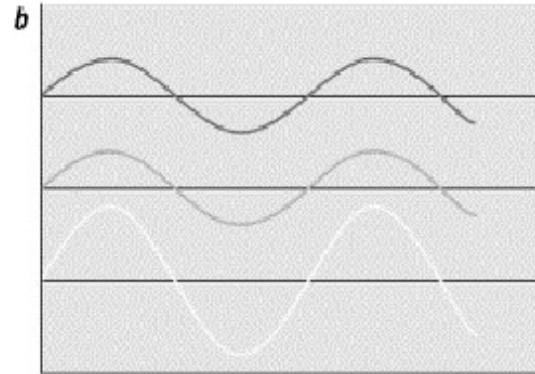
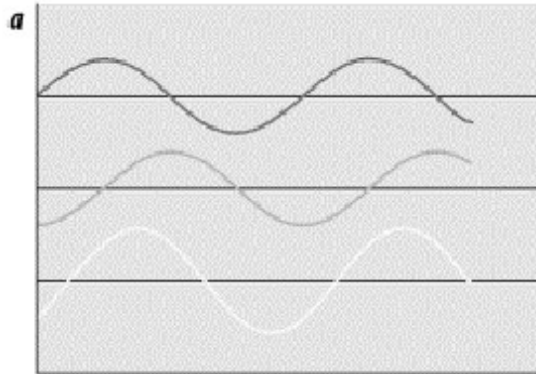

KEY	
	Wave 1
	Wave 2
	Sum

When multiple waves converge on a point, the total wave is simply the sum of any component waves

Wave “aggregation” by superposition

When two or more waves traverse the same space, the net amplitude at each point is the sum of the amplitudes of the individual waves

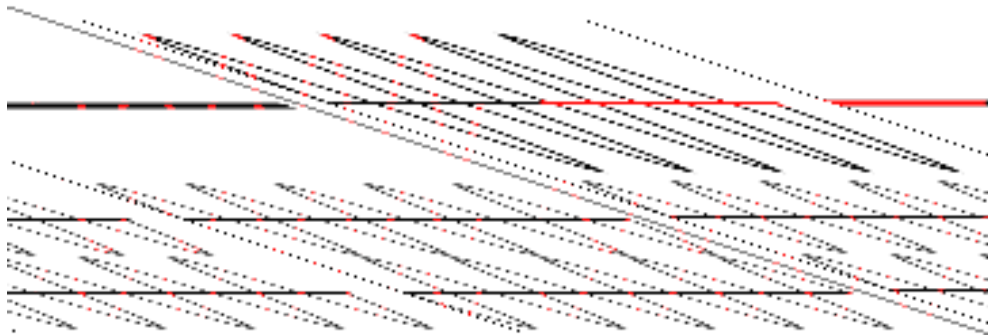

Destructive interference: when the summed variation has a smaller [amplitude](#) than the component variations (e.g., noise-cancelling headphones)

Constructive interference: when the summed variation will have a bigger amplitude than any of the components individually (e.g., Line Array)

Wireless channels



- Operate through **electromagnetic radiation** from the transmitter to the receiver
- In principle, one could *solve the electromagnetic field equations*, in conjunction with *the transmitted signal* to find the **electromagnetic field impinging on the receiver antenna**
 - ⊖ This would have to be done taking into account the **obstructions** caused by ground, buildings, vehicles, etc in the vicinity of this electromagnetic wave
- Multiple copies of the signal could be propagated and reach the receiver (Το σήμα φτάνει από διαφορετικές κατευθύνσεις, με διαφορετικές καθυστερήσεις, ακολουθώντας διαφορετικές διαδρομές)
- Το σήμα που λαμβάνεται στον δέκτη αποτελείται δυνητικά από έναν αριθμό σημάτων με διαφορετική ένταση, φάση και γωνία άφιξης⁷⁹

Fundamentals



- Impairments
- Radio Propagation
- Wireless channel model
- Digital modulation and detection techniques
- Error control techniques

Types of Impairments



- Noise: **thermal** (electronics at the receiver, λόγω της τυχαίας κίνησης των ηλεκτρονίων σε έναν αγωγό), **human**

Εξωτερικές πηγές (πχ ατμοσφαιρικός, γαλαξιακός, βιομηχανικός) & εσωτερικές πηγές (πχ στιγμιαίων διακυμάνσεων του ρεύματος ή τα τάσης στα ηλεκτρικά κυκλώματα) θορύβου

- Radio frequency signal path loss
- Fading at low rates
- **Inter-Symbol interference (ISI)**
- **Shadow fading**
- **Co-channel interference**
- **Adjacent channel interference**

Radio Frequency Wave Propagation

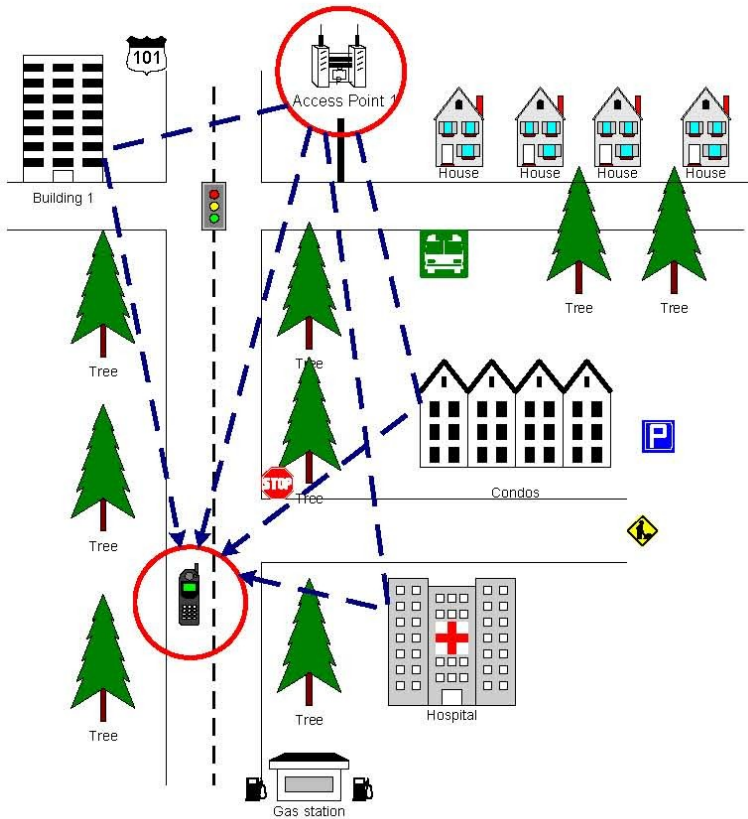

Multipath Fading

- caused by multiple reflections

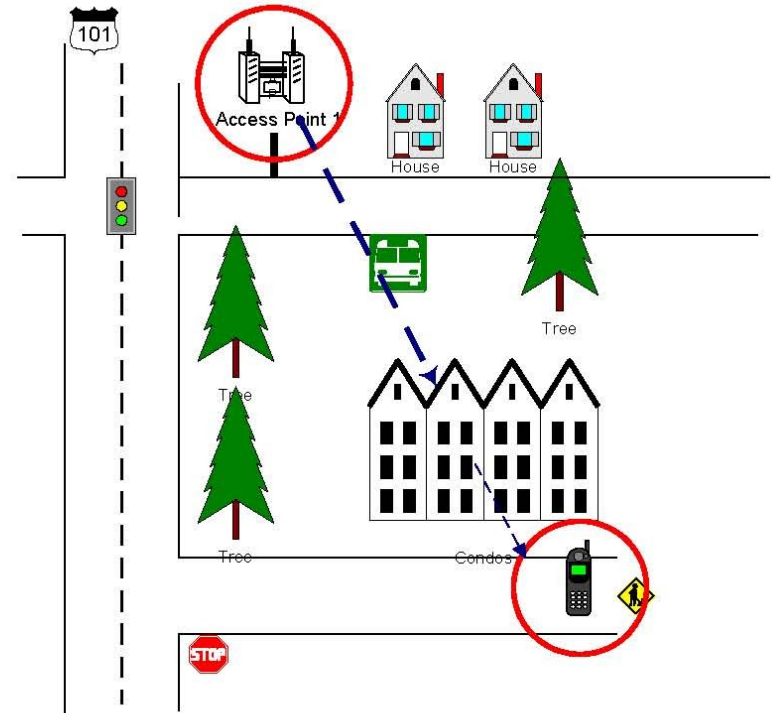

Shadowing

- caused by physical obstructions

Multipath fading



Multipath: the propagation phenomenon that results in radio signals reaching the receiving antenna by two or more paths

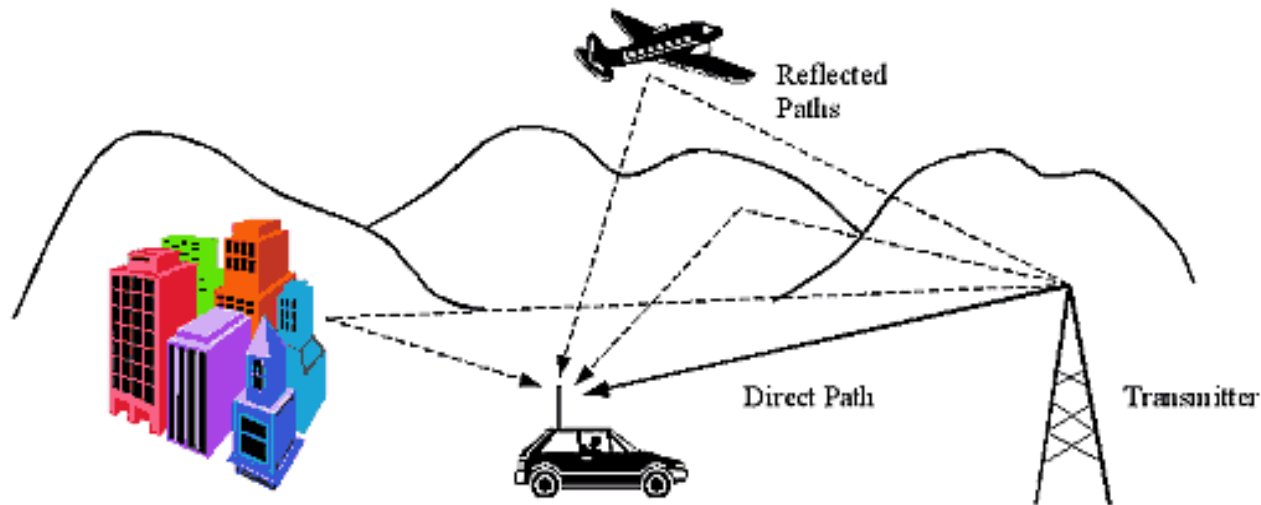

Channel impulsive response

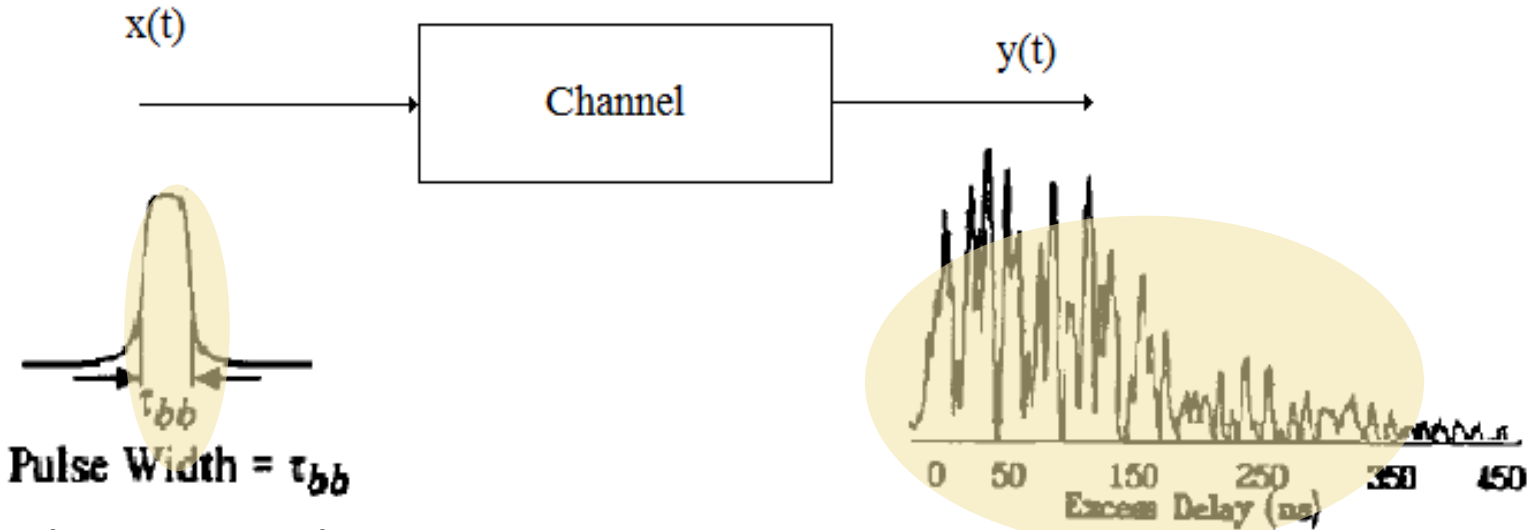

Pulse Width = τ_{bb}

Διάρκεια συμβόλου

- By sending a **pulse** of very small duration to the channel, the **impulsive response** can be estimated
- At the output, the **duration of the pulse is extended** due to **multipath**

Μπορούμε να θεωρήσουμε ότι το multi-path φαινόμενο έχει ως αποτέλεσμα το κανάλι να συμπεριφέρεται σαν φίλτρο στο πεδίο των συχνοτήτων: όπου ενισχύει άλλες συχνότητες, κι άλλες τις εξασθενεί

Frequency Selective Fading due to Multipath



- The frequency response of a fading channel is not constant within the available bandwidth
 - The channel gain may **vary for different frequencies** of the transmitted signal (e.g., due to multi-path)
 - Channel gain: συντελεστής που εκφράζει την επίδραση στο μεταδιδόμενο σήμα

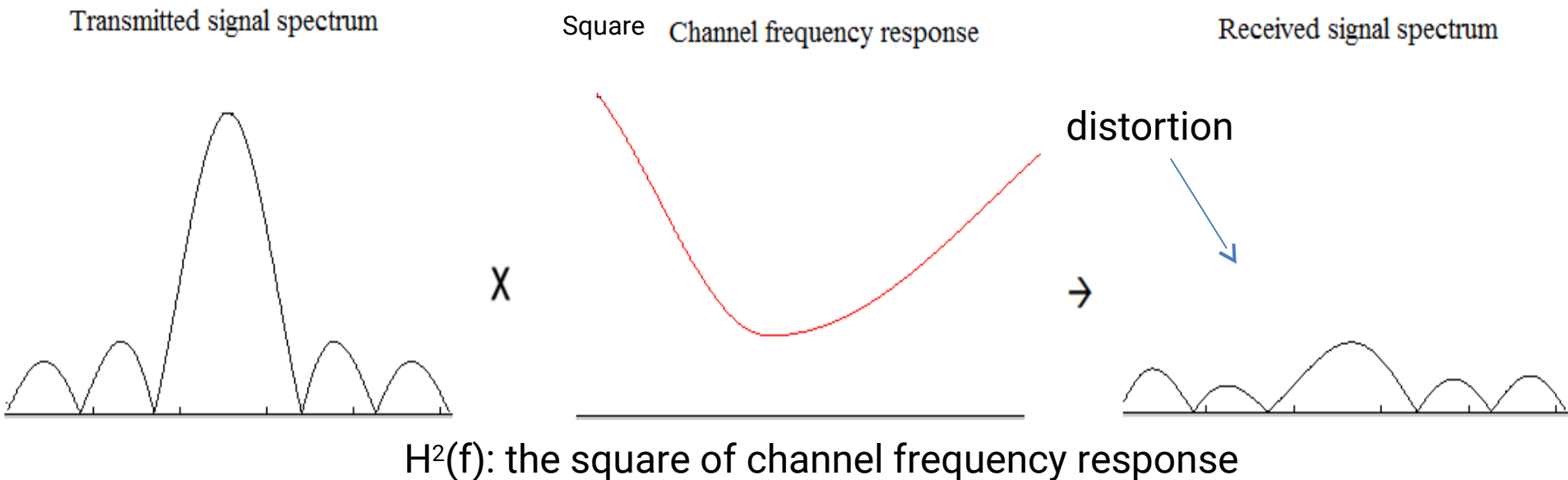

Το παραπάνω παράδειγμα δείχνει ένα κακής ποιότητας κανάλι, μια και παραμορφώνει σημαντικά τα φασματικά χαρακτηριστικά του μεταδιδόμενου σήματος (πχ κύριος λοβός έχει σχεδόν εξαφανιστεί)

Main issues in wireless communications



Fading: *time variation* of signal strength due to:

- **Small-scale** effect of multipath fading
- **Larger-scale** effects, such as
 - **Path loss** via distance attenuation
 - **Shadowing** via obstacles

Interference

Unlike the wired world, where transmitter-receiver pair can often be thought of as **isolated point-to-point link**, wireless users communicate over the air & there is significant interference between them

Types of fading



- Large-scale fading, due to **path loss of signal** as function of **distance** & **shadowing** by large objects (hills, buildings)
 - This occurs as wireless devices move through a **distance of the order of cell size** and is typically **frequency independent**
 - large transmitter-receiver distances
- Small-scale fading, due to **constructive & destructive interference** of **multiple signal paths** between transmitter & receiver
 - This occurs at the **spatial scale of the order of the carrier wavelength** and is **frequency dependent**
 - rapid fluctuations of the received signal strength** over **very short travel distances** or **short time durations** (order of seconds)



Channel quality varies over multiple time-scales

Signal strength changes over time and space

Stochastic processes to model signal strength

- Challenging task
- Environments with **mobility and obstacles**

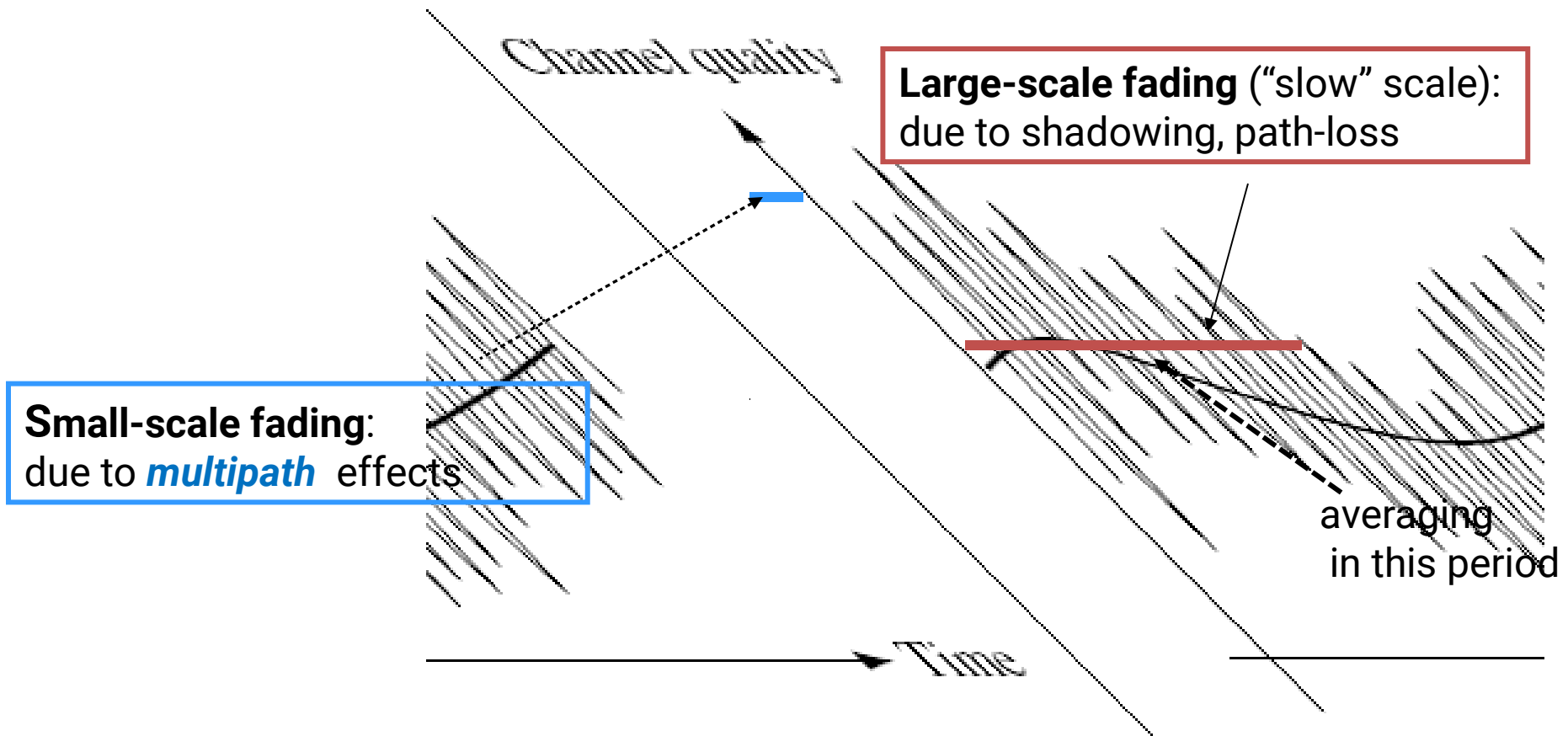

Large, medium & small-scale fading



Fading: fluctuation in the received signal power

- Large-scale fading: **average signal power attenuation**/path loss due to **motion over large areas**.
- Medium-scale fading: **local variation in the average signal power** around mean average power **due to shadowing by local obstructions**.
- Small-scale: large variation in the signal power due to small changes in the distance between transmitter & receiver

Also called **Rayleigh fading** when no LOS available. It is called Rayleigh due to the fact that **various multipaths at the receiver** with random amplitude & delay add up together to render rayleigh PDF for total signal

With Rayleigh Fading



Thanks to Nitin Jain's presentation on intro to wireless fading slides

Multipath fading



Fluctuation in the received power due to

- Variations in the received signal amplitude
- Variation in the signal phase
- Variations in the received signal angle of arrival (different paths travelling different distances may have different phases & angle of arrival)

There is signal superimposition ...



RF Communications

Radio Frequency (RF) waves are effected by

- Distance between the transmitter and receiver
 - ♦ Inverse power law
- Reflection (e.g. ground reflection)
- Diffraction (e.g. from building)
- Scattering (e.g. from trees)
- Links may not be bi-directional
 - ♦ **A can hear B, but B can't hear A** (e.g. because of receiver sensitivity)
- Radio waves may be blocked (absorbed) by objects
 - ♦ e.g by buildings, humans, rain, walls, glass windows

↕
Path Loss

↕
Multipath Fading

Related to the asymmetry in wireless links network characteristics one direction may be different than those in the opposite direction

↕
Shadowing

Degree of attenuation generally depends on frequency

Different types of fading

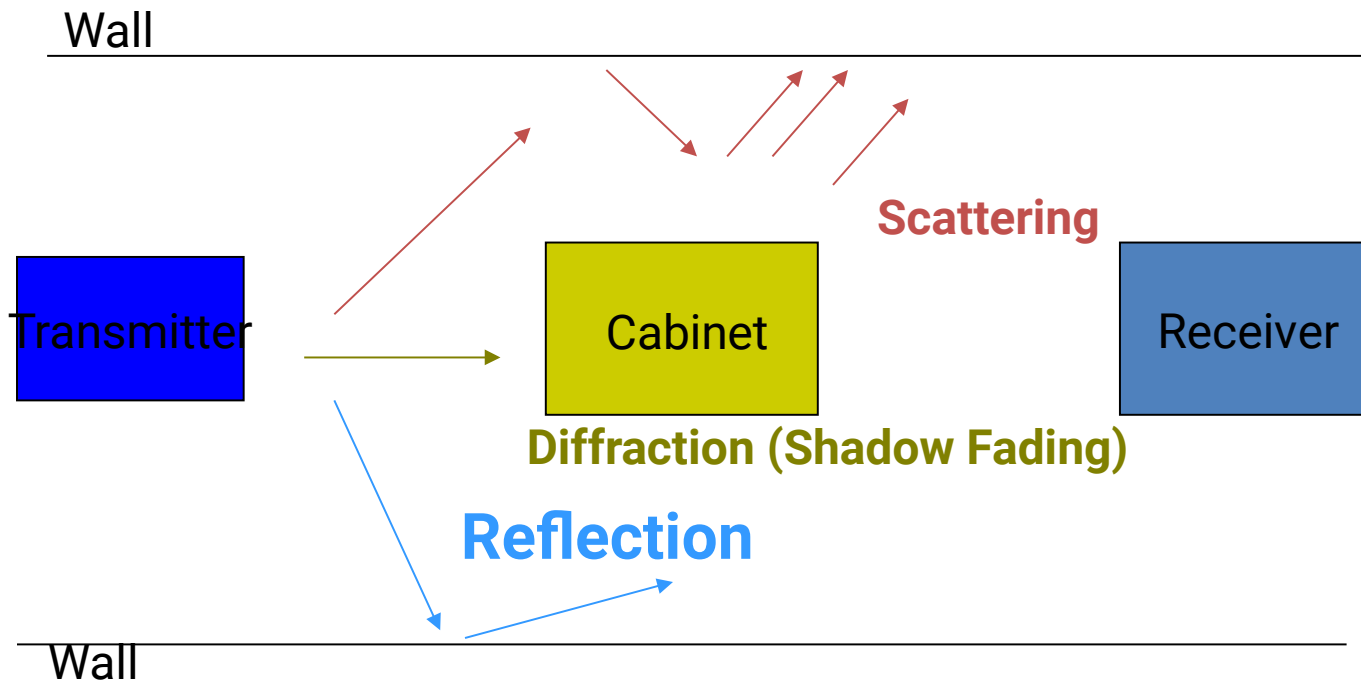

Example of multi-path effect

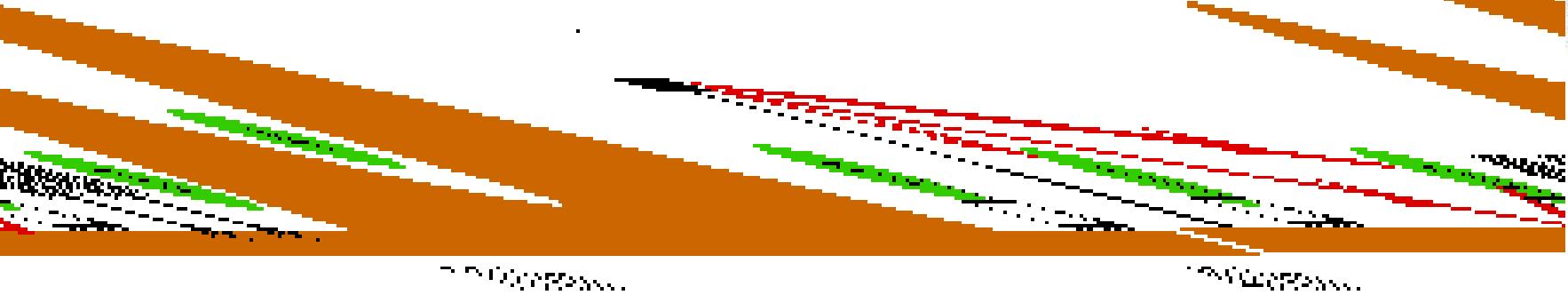
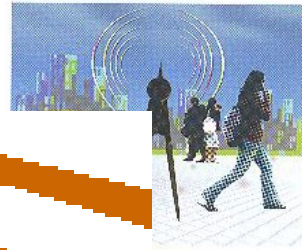

- @ 1: **free space loss** likely to give an accurate estimate of path loss
- @ 2: strong line-of-sight but **ground reflections** can significantly influence path loss
- @3: significant **diffraction** losses caused by trees cutting into the direct line of sight
- @ 4: simple **diffraction** model for path loss
- @ 5: multiple diffraction, loss prediction fairly **difficult & unreliable**

Diffraction

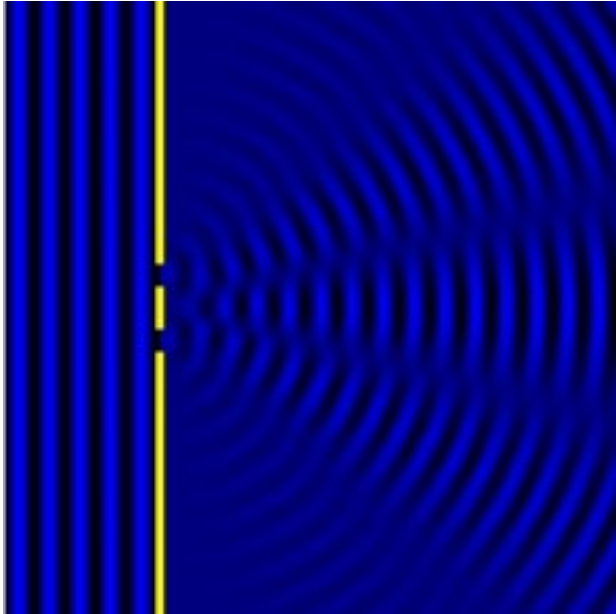

Diffraction refers to various phenomena which occur when a wave encounters an obstacle.

In classical physics, the diffraction phenomenon is described as the apparent bending of waves around small obstacles and the spreading out of waves past small openings.

Shadow Fading



- **Obstacles** and their **absorption behavior**
- Shadowing differs from multi-path fading
 - **Duration** of shadow fade lasts for **multiple seconds or minutes**
a **much slower time-scale** compared to multi-path fading

Reflection



- Wave impinges upon a large object when compared to the wavelength of the propagating wave
- Reflections occur from the surface of
 - The earth
 - Buildings
 - Walls

Scattering



- Another **type of reflection**
- Can occur in the atmosphere or in reflections from **very rough** objects
- **Very large number of individual paths**
 - ≡ Received waveform is better modeled as an **integral over paths** with **infinitesimally small differences in their lengths** rather than as a sum

Multi-path Delay Spread



- **Time** between the **arrival** of the *first wavefront* & *last multi-path echo*,
counting **only the paths with significant energy**
- Longer delay spreads require more conservative coding
- 802.11b networks can handle delay spreads of < 500 ns
- Performance is much better when the delay spread is low
- When delay spread is large
cards may reduce transmission rate

Inter-Symbol Interference (ISI)



Waves that take **different paths** from the transmitter to the receiver:

- travel different distances
- **be delayed** with respect to each other
- Waves are **combined by superposition** but the effect is that the total waveform is garbled

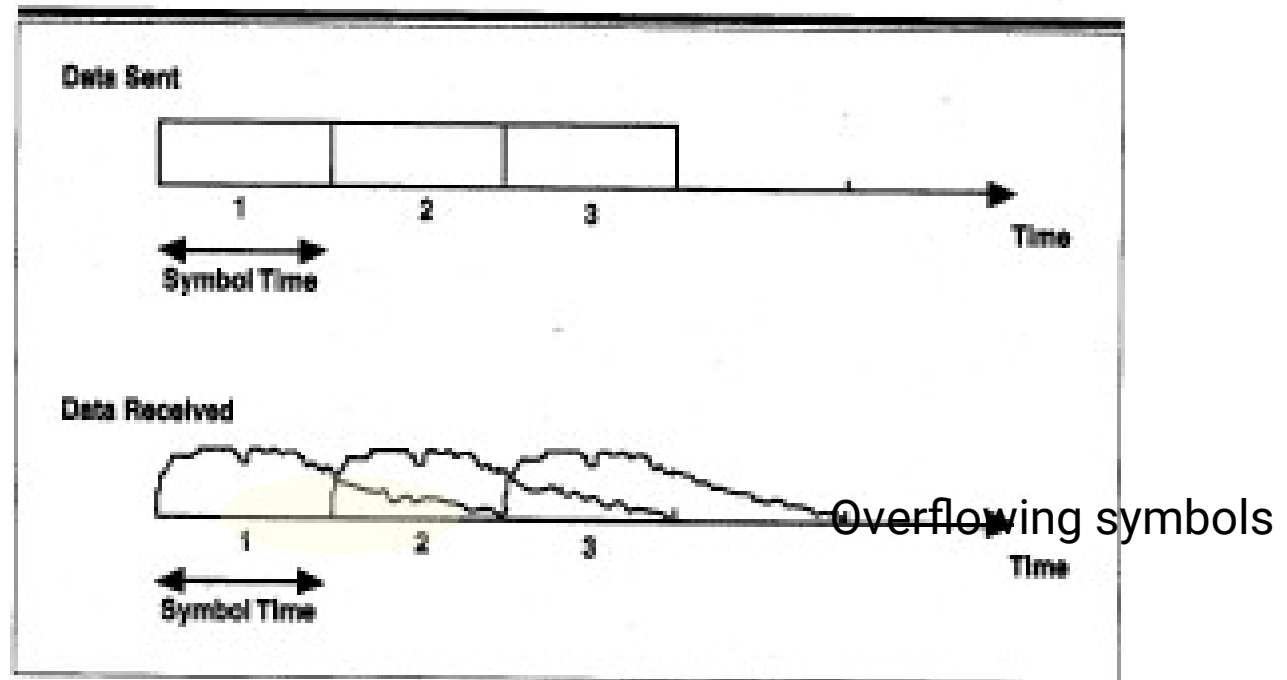

Παρατηρείστε ότι το σήμα εκτίνεται σε μεγαλύτερη διάρκεια από αυτή του συμβόλου (και παρεμβάλλεται στα γειτονικά σύμβολα). Αυτό οφείλεται στο multi-path φαινόμενο.

Distortion



- Caused by the **propagation speed & fading**
- Depends on the **frequency** (*varies in different frequencies*)

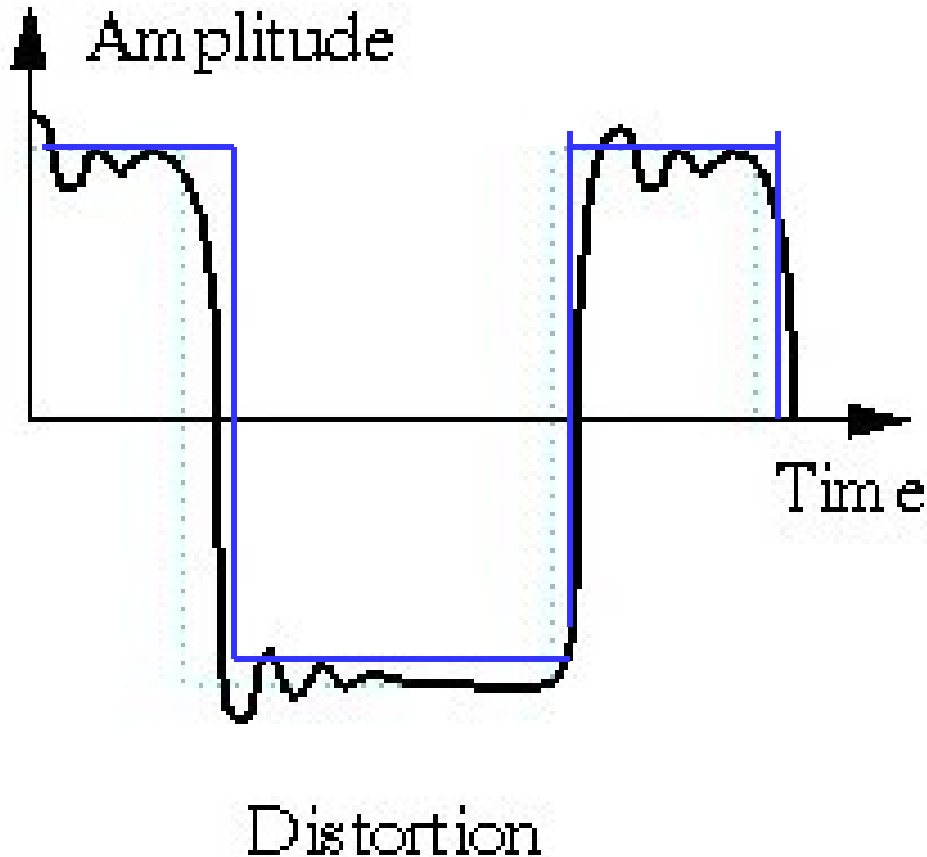

Different frequencies
suffer different attenuation

Frequency Selective Fading:
the **channel gain** varies for
different frequencies
of the transmitted signal

Frequency Selective Fading



- The frequency response of a **fading channel** is **not constant** within the available bandwidth
 - The **channel gain** may **vary for different frequencies** of the transmitted signal

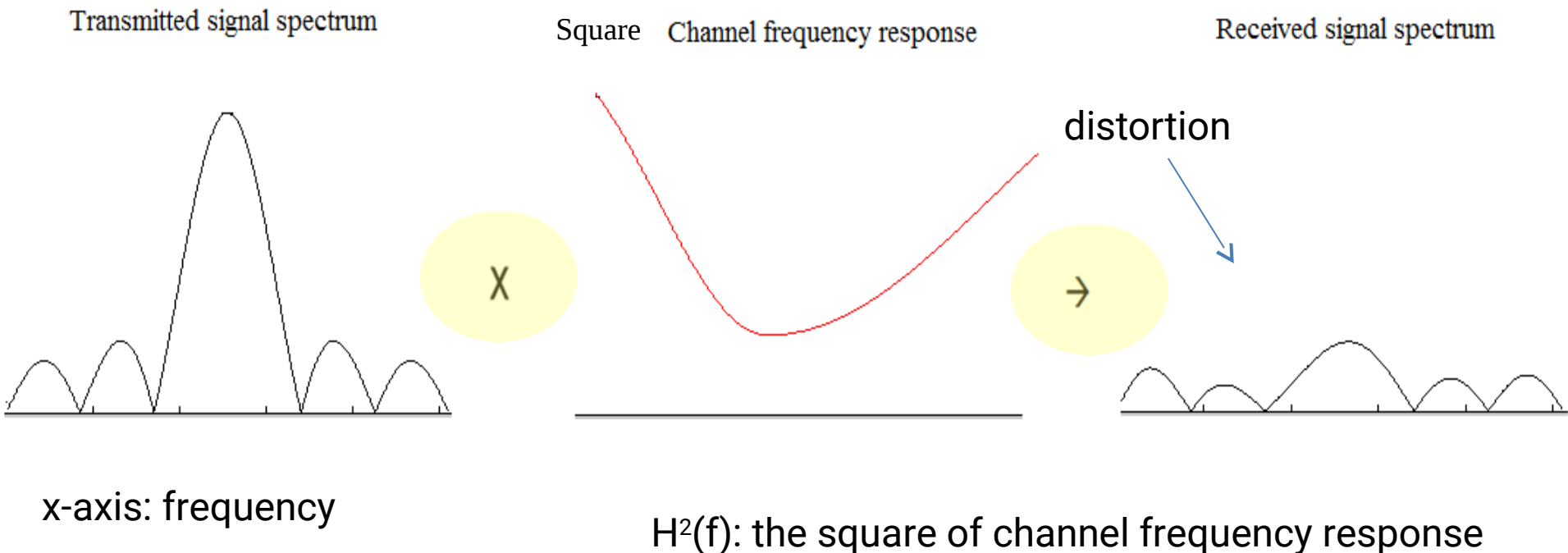

Channel Impulse Response



- If the **channel is stationary over a small time interval** the **channel impulse response** may be written as:

(κρουστική απόκριση)

$$h(t) = \sum_{i=0}^{N-1} a_i \exp(j\theta_i) \delta(t - t_i)$$

- a_i & θ_i : the amplitude & phase of the i^{th} **multipath copy**
- t_i : time of arrival of the i^{th} copy
- $\delta(t)$ is the Dirac function

Βλέπουμε ότι το $h(t)$: άθροισμα από Dirac συναρτήσεις

Η συνάρτηση εξόδου είναι η συνέλιξη (convolution) του σήματος εισόδου και της κρουστικής απόκρισης του καναλιού.

Channel Impulse Response



- If the **channel is stationary over a small time interval** the channel impulse response may be written as:

$$h(t) = \sum_{i=0}^{N-1} a_i \exp(j\theta_i) \delta(t - t_i)$$

- a_i & θ_i : the amplitude & phase of the i^{th} **multipath copy**
- t_i : time of arrival of the i^{th} copy
- $\delta(t)$ is the Dirac function
- Channel frequency response $H(f)$: Fourier transform of $h(t)$

$$H(f) = \int_{-\infty}^{+\infty} h(t) e^{-j2\pi ft} dt$$

Power Spectral Density of the Received Signal



The power spectral density of the **received signal** (S_r) is equal to the power spectral density of the **transmitted signal** (S_t) multiplied by the **square of the amplitude of the channel frequency response**

$$S_r = |H(\omega)|^2 S_t$$

Doppler Effect



- The Doppler effect is observed whenever the source of waves is moving with respect to an observer
- It is the effect produced by a moving source of waves in which there is an apparent upward (downward) shift in frequency for observers towards whom the source is approaching (receding), respectively

Doppler Effect: Example

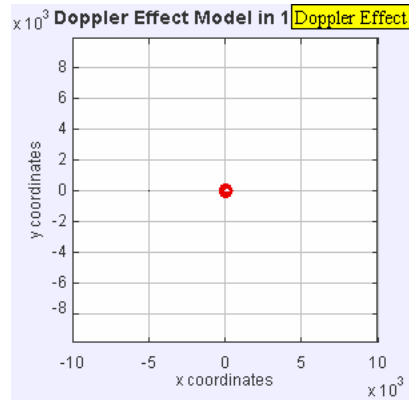
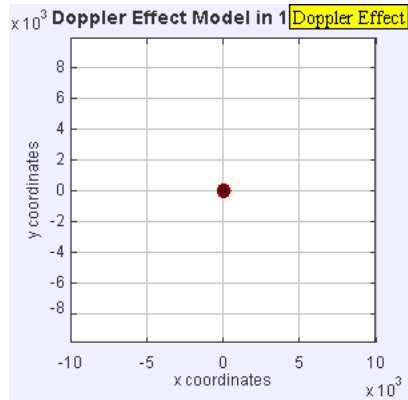

The same sound source is radiating sound waves at a constant frequency in the same medium. However, now the sound source is moving with a certain speed. Since the source is moving, the centre of each new wavefront is now slightly displaced to the right. As a result, the wave-fronts begin to bunch up on the right side (in front of) and spread further apart on the left side (behind) of the source. An observer in front of the source will hear a higher frequency and an observer behind the source will hear a lower frequency.

Doppler spread



When a **sinusoidal pulse of frequency f_c is transmitted** over a **multi-path channel**, the received spectrum will have components in the **range $f_c - f_d$ to $f_c + f_d$**

f_d : Doppler spread:
$$f_d = \frac{v}{\lambda} \cos(\theta)$$

- v : *velocity of the receiver*
- θ : *direction of arrival of the received signal*
- λ : *wavelength*

Coherence time



Definition:

- The time interval over which the **channel impulsive response is considered stationary**

Typical assumption:

- Doppler spread and coherence time are related by the formula:

$$T_c = \frac{K}{f_d}$$

K : constant in the range of 0.25 to 0.5

Time Variance: Fast Fading



- The channel changes drastically many times while a symbol is propagating

Causing:

- Severe distortion of baseband pulse leading to detection problems
- Loss in SNR
- Synchronization problems



Time Variance: Slow Fading

- The channel does NOT change drastically during the symbol propagation causing: Loss in SNR



Propagation Models (Large-scale fading)

- One of the most difficult part of the radio channel design
- Done in **statistical fashion** based on measurements made specifically for an intended communication system or spectrum allocation
- Predicting the **average signal strength** at a given **distance from the transmitter**

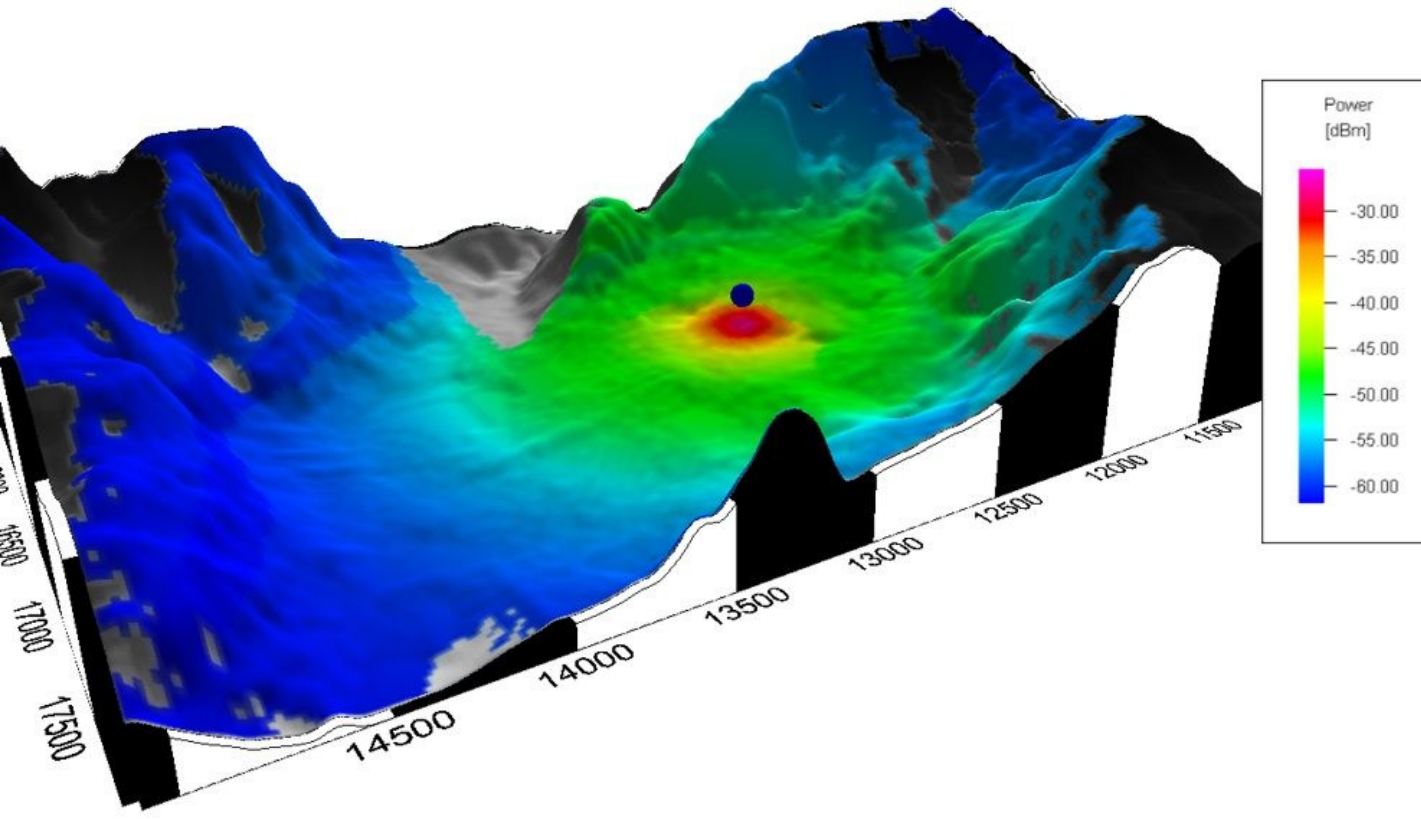

Some Real-life Measurements

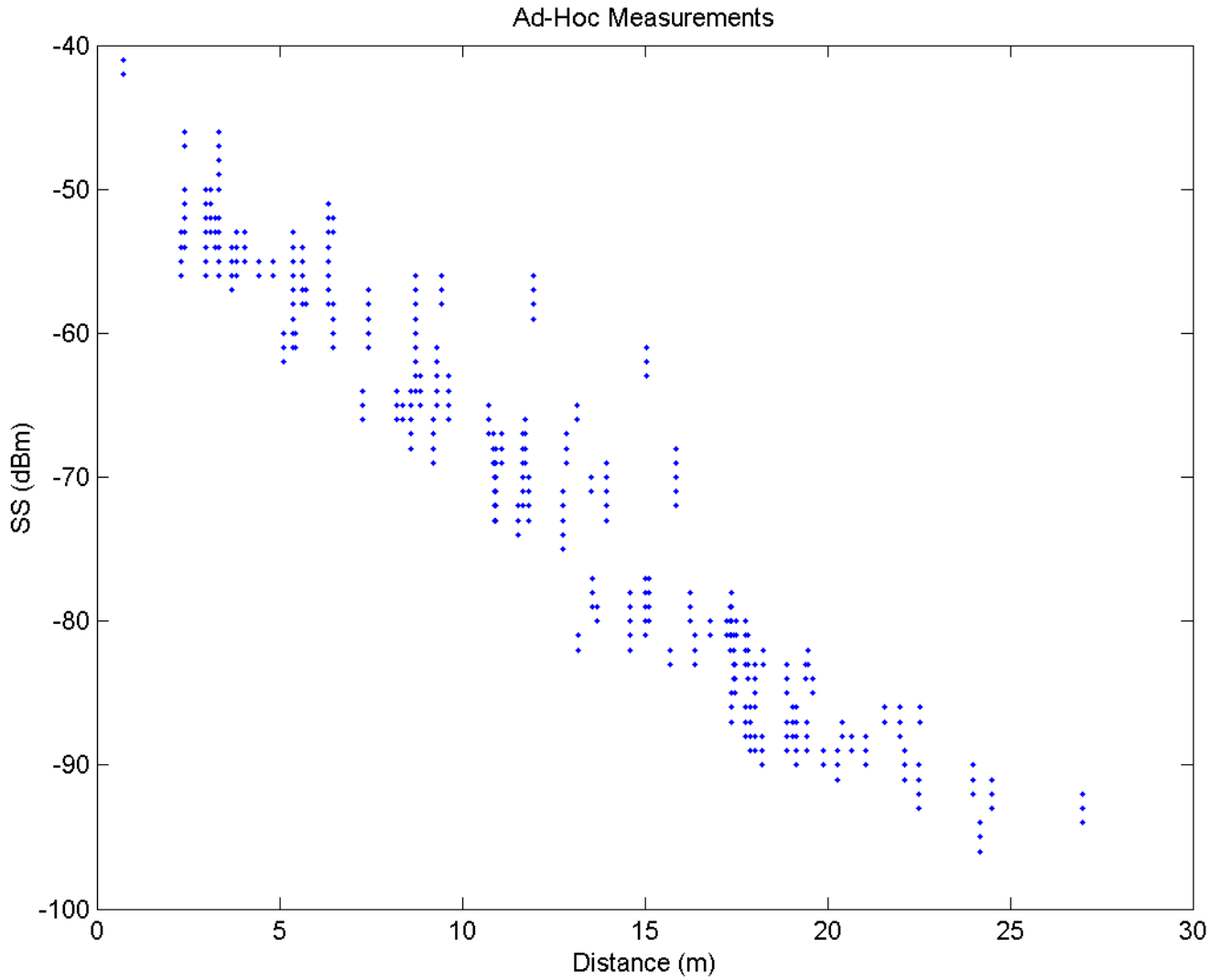

Signal Power Decay with Distance



± A signal traveling from one node to another experiences fast (multipath) fading, shadowing & path loss

○ **Ideally, averaging RSS** over sufficiently long time interval **excludes the effects of multipath fading & shadowing** □□
general **path-loss model**:

$$\bar{P}(d) = P_0 - 10n \log_{10} (d/d_0)$$

n : path loss exponent

$\bar{P}(d)$: the average received power in dB at distance **d**

P_0 is the received power in dB at a short distance **d_0**

Path loss exponents for different environments



Environment	Path Loss Exponent, n
Free space	2
Urban area cellular radio	2.7 to 3.5
Shadowed urban cellular radio	3 to 5
In building line-of-sight	1.6 to 1.8
Obstructed in building	4 to 6
Obstructed in factories	2 to 3

Path loss model for various cities in Germany

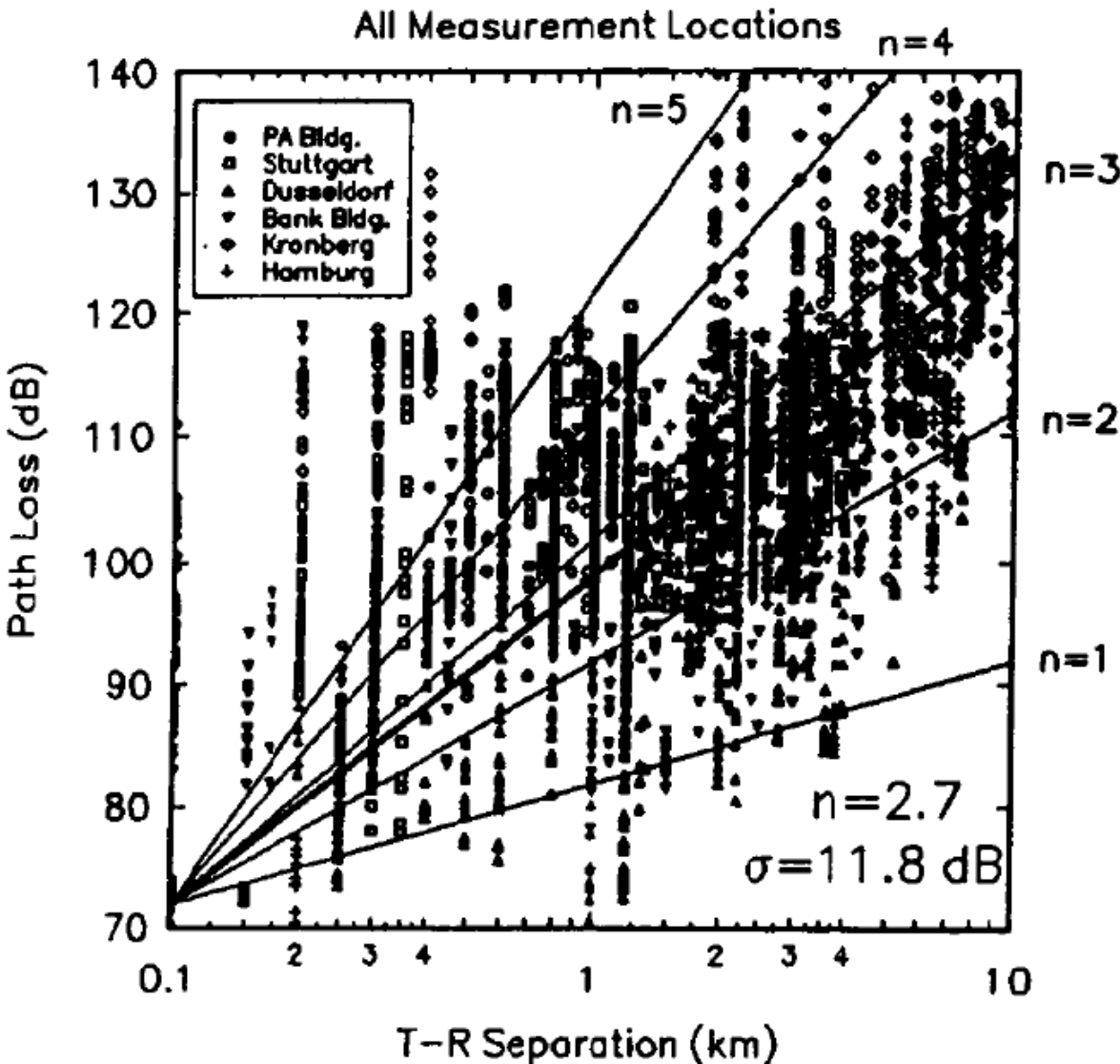

Parameters

- $n=2.7$
 - $\sigma=11.8$ dB
- correspond to all cities

Free-space Propagation Model



- Assumes a **single direct path** between the base station and the mobile
- Predicts received signal strength when the transmitter & receiver have a **clear, unobstructed line-of-sight path between them**
- Typically used in an **open wide environment**
Examples: satellite, microwave line-of-sight radio links

Free-space Propagation Model



Derived from first principles: **power flux density** computation

- Any radiating structure produces electric & magnetic fields:
its **current** flows through such antenna and
launches **electric** and **magnetic fields**
- The electrostatic and inductive fields
decay much faster with distance than the radiation field
- At regions far way from the transmitter:
the **electrostatic & inductive fields** become negligible and
only the radiated field components need be considered

Free-space Propagation Model



$$P_r(d) = P_t G_t G_r \lambda^2 / [(4\pi)^2 d^2 L]$$

P_t, P_r : transmitter/receiver power

G_t, G_r : transmitter/receiver antenna gain

$$G = 4\pi A_e / \lambda^2$$

L : system loss factor ($L=1$ no loss)

A_e : related to the physical size of the antenna

λ : wavelength in meters, f carrier frequency, c : speed of light

$$\lambda = c/f$$

Two-ray ground reflection model

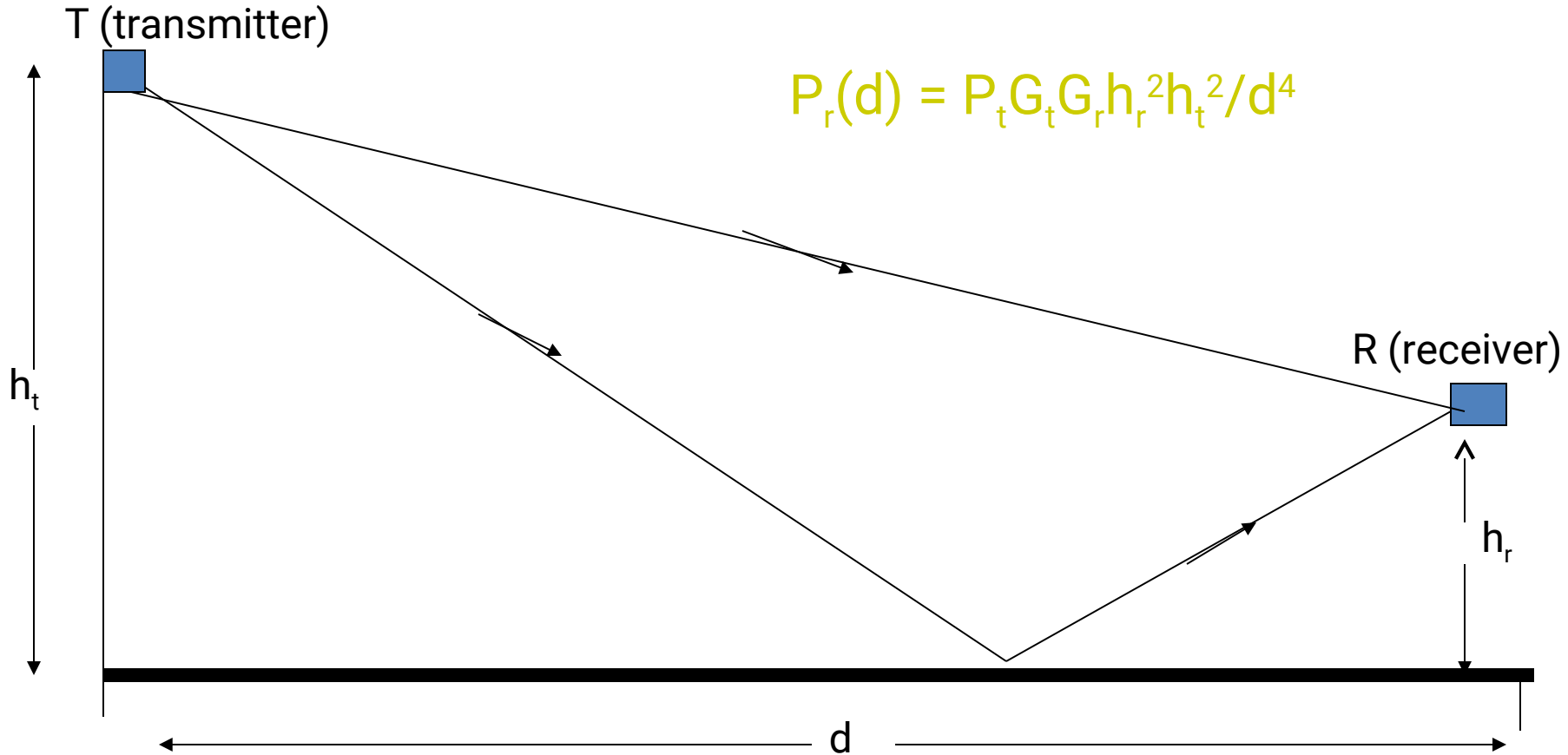

Two-ray Ground Reflection Model



Considers both the *direct path* & *a ground reflected propagation path* between transmitter and receiver

- Reasonably **accurate** for predicting the **large-scale** signal strength
 1. over distances of several km for mobile radio systems that use tall tower (heights which exceed 40m)
 2. for line-of-sight micro-cell channels in urban environment

Multiple Reflectors



- Use ray tracing
- Modeling the received waveform as the *sum* of the *responses* from the *different paths* rather than just two paths
- Finding the *magnitudes* and *phases* of these responses is not a simple task

Multi-path Delay Spread



- **Difference in propagation time** between the **longest** and **shortest** path, counting **only the paths with significant energy**

Modeling Electromagnetic Field



- In the cellular bands the wavelength is a fraction of meter
- To calculate the electromagnetic field at the receiver, the locations of the receiver and the obstructions would have to be known with **sub-meter accuracies**.

Free space Fixed transmit & Receive Antennas



In the far field, the **electric field** and **magnetic field** at any given location are

- **perpendicular** both to each other & to the direction of propagation from the antenna
- **proportional to each other**

Free-space fixed transmit & receive antennas



In response to a transmitted sinusoid $\cos(2\pi ft)$, the *electric far field* at time t can be expressed as:

$$E(f, t, (d, \theta, \psi)) = a_s(\theta, \psi, f) \cos(2\pi f(t-d/c)) / d$$

vertical & horizontal angles **from the antenna to u**

Radiation pattern of sending antenna at frequency f (incl. antenna loss)

point u in space @ which the electric field is being measured

d distance from the transmit to receive antennas

Physical-layer Model – Criterion for Successful Transmission



- $\{X_k; k \in \mathcal{T}\}$ subset of nodes **simultaneously** transmitting at some time instance over a certain sub-channel.
- P_k Power level chosen by node X_k

$X_i, i \in \mathcal{T}$, is successfully received by a node X_j if

ambient noise power level

$$N + \frac{P_i}{|X_i - X_j|^\alpha} \geq \sum_{\substack{k \in \mathcal{T} \\ k \neq i}} \frac{P_k}{|X_k - X_j|^\alpha}$$

minimum

Signal-to-interference ratio

$$\geq \beta$$

Signal power decays with distance

Signal-to-noise ratio (SNR)



- The ratio between the magnitude of **background noise** and the magnitude of **un-distorted signal** (meaningful information) on a channel
- Higher SNR is better (i.e., cleaner)
- It determines how much information each symbol can represent

Capacity of a channel



How **many bits of information can be transmitted without error** per sec over a channel with

- **bandwidth B**
- average **signal power P**
- the signal is exposed to an **additive, white (uncorrelated) noise of power N with Gaussian probability distribution**

○ provides the **fundamental limit of communication achievable by any scheme**

Limits of wireless channel



- Shannon [1948] defined the capacity limit for communication channels

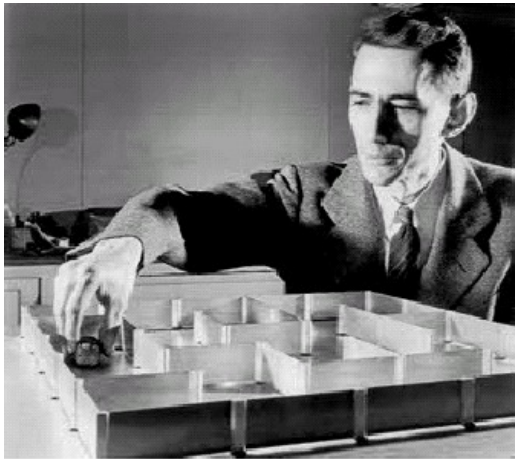

Shannon (1916-2001)

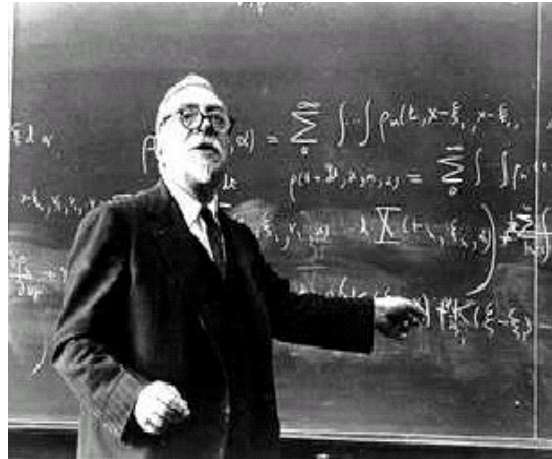

Norbert Wiener (1894-1964)

Shannon's limit



- For a channel *without shadowing, fading, or ISI*, the **maximum possible data rate** on a given channel of **bandwidth B** is

$$R = B \log_2(1 + \text{SNR}) \text{ bps,}$$

where **SNR** is the received signal to noise ratio

Shannon's is a theoretical limit that cannot be achieved in practice but design techniques improve data rates to approach this bound

Digital Radio Communications

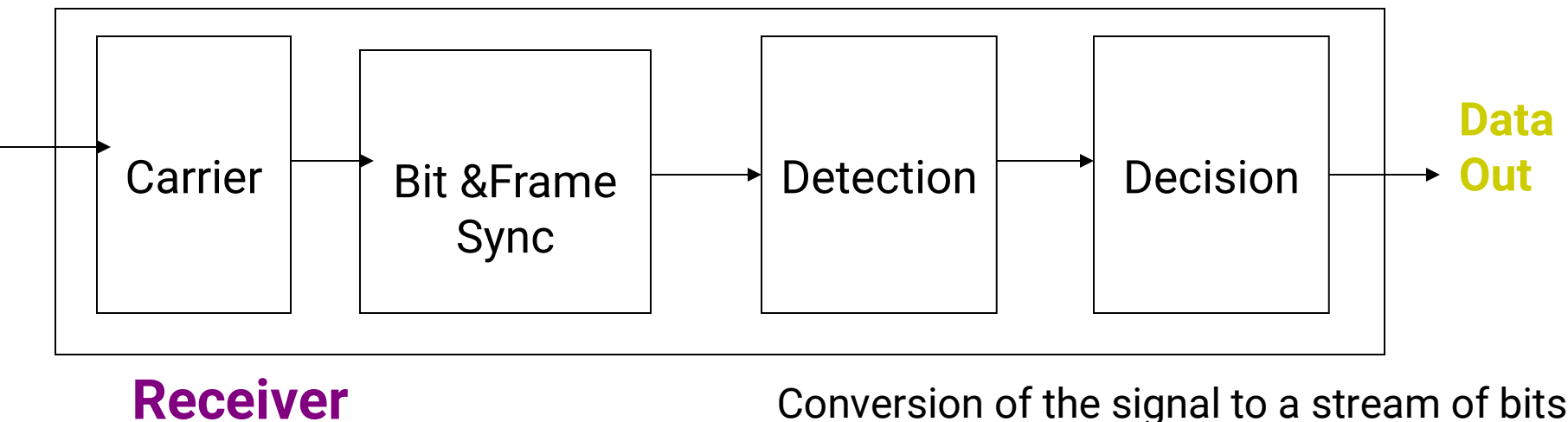
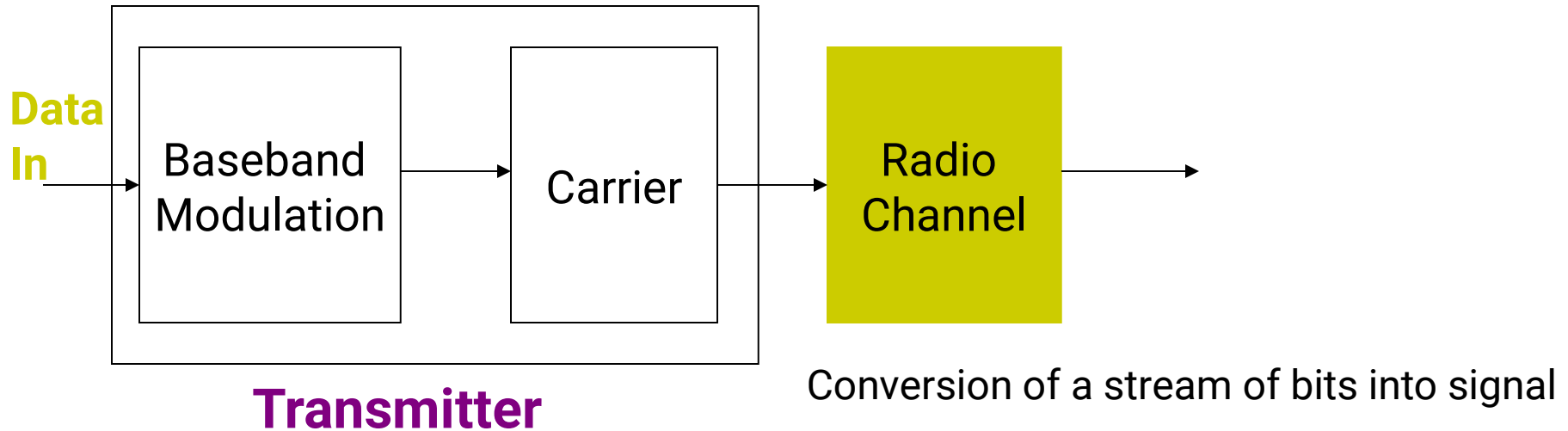

Conversion of a stream of bits into signal

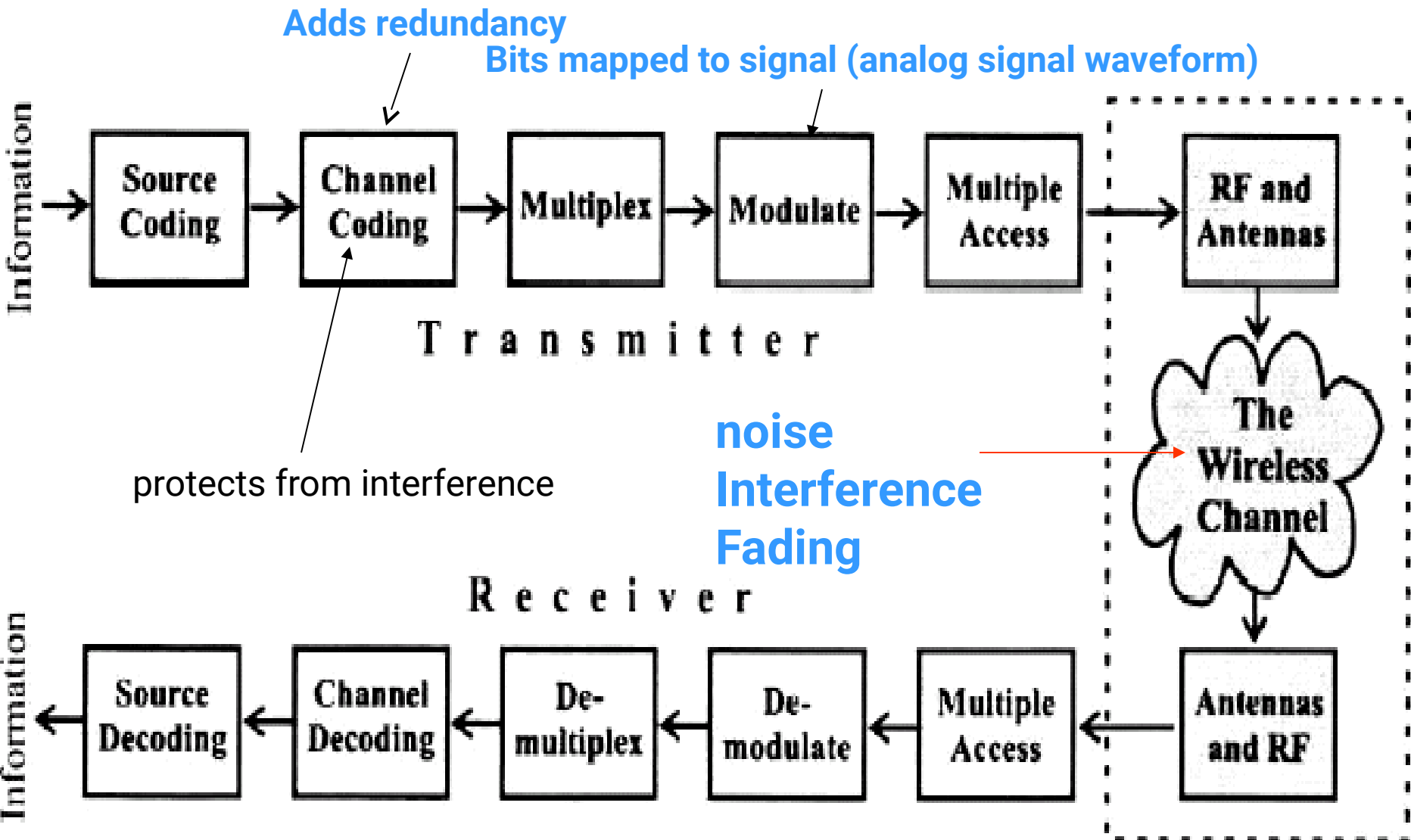



Adds redundancy to protect the digital information from noise and interference

Bits mapped to signal (analog signal waveform)

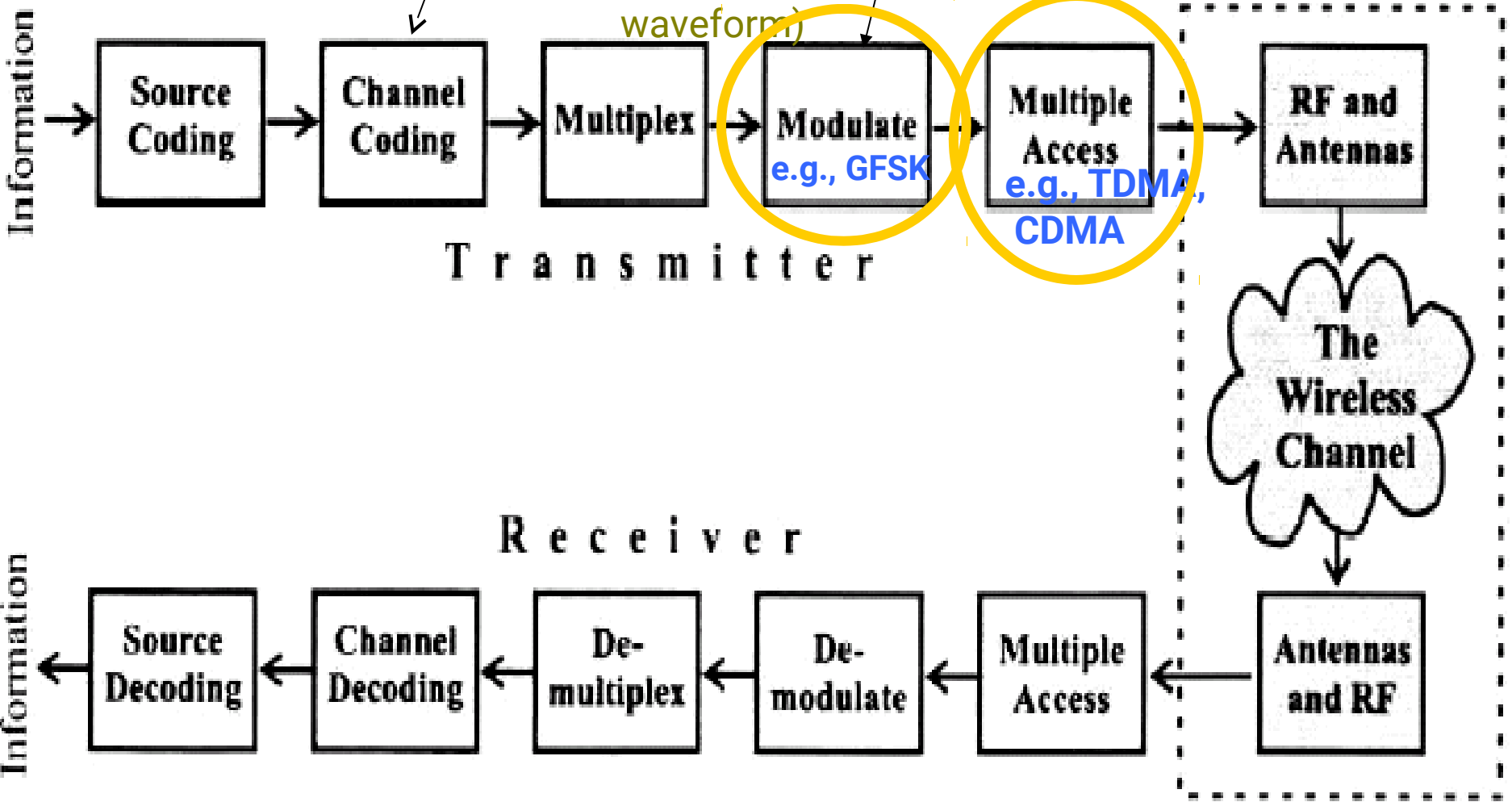

T r a n s m i t t e r

R e c e i v e r

Channel Coding



- **Protects** the digital information from noise & interference & reduces the number of bit errors
- Accomplished by **selectively introducing redundant bits** into the transmitted information stream
- These additional bits allow **detection & correction of bit errors** in the received data stream

Encoding



- Use two discrete signals, high and low, to encode 0 and 1
- Transmission is synchronous, i.e., a clock is used to sample the signal
 - In general, the duration of one bit is equal to one or two clock ticks
 - Receiver's clock must be synchronized with the sender's clock
- Encoding can be done one bit at a time or in blocks of, e.g., 4 or 8 bits

Why Do We Need Encoding?



- Meet certain electrical constraints
 - Receiver needs enough “transitions” to keep track of the transmit clock
 - Avoid receiver saturation
- Create control symbols, besides regular data symbol
 - e.g. **start or end of frame**
- Error detection or error corrections
 - Some codes are illegal so receiver can detect certain classes of errors
 - Minor errors can be corrected by having multiple adjacent signals mapped to the same data symbol
- Encoding can be very complex, e.g. wireless

Digital Modulation



The process of

- taking information from a message source (**baseband**) in a suitable manner for transmission &
- translating the **baseband** signal onto a radio carrier at **frequencies that are very high** compared to the baseband frequency

Why not modulate the baseband



- ⊖ For effective signal radiation the **length of the antenna** must be **proportional to the transmitted wave length**
 - For example, voice range 300-3300Hz
 - At 3kHz at 3kbps would imply an antenna of 100Km!
 - By modulating the baseband on a 3GHz carrier the antenna would be 10cm
- To ensure the **orderly coexistence of multiple signals** in a given spectral band
- To **help reduce interference** among users
- For **regulatory reasons**

Demodulation



The process of **extracting the baseband** from the carrier so that it may be **processed and interpreted** by the receiver (e.g., symbols detected and extracted)

Signal Representation



- each signal can be written as a linear combination of a sinusoidal and cosusoidal functions

$$c * \sin(2\pi F_c * t + \varphi) = a * \sin(2\pi F_c * t) + b * \cos(2\pi F_c * t)$$

Οι βάσεις του χώρου είναι το ημίτονο και το συνημίτονο. Επομένως το παραπάνω σήμα μπορεί να αντιπροσωπευθεί με ένα σημείο (a,b)

Signal Representation



- each signal can be written as a linear combination of a sinusoidal and cosusoidal functions

$$c * \sin(2\pi F_c * t + \varphi) = a * \sin(2\pi F_c * t) + b * \cos(2\pi F_c * t)$$

Οι βάσεις του χώρου είναι το ημίτονο και το συνημίτονο. Επομένως το παραπάνω σήμα μπορεί να αντιπροσωπευθεί με ένα σημείο (a,b)

Digital Modulation Approaches



- Frequency shift Keying (FSK)
 - Use of **different carrier frequencies** to encode the various symbols
- Phase shift Keying (PSK)
 - Use of a **single carrier frequency**
 - The various symbols are **encoded by the phase**
- Quadrature Amplitude Modulation(QAM)
 - Both **phase & amplitude** are used for the encoding of various symbols

FSK modulation



- An alphabet of **M symbols** is used ($M = 2^K$ for some $K \in \mathbb{N}$)
 - Each symbols corresponds to a combination of K bits
- The **i -th symbol** is mapped to **carrier frequency $F_i = (n+i)/2T$**
 - T : symbol duration
 - n : arbitrary integer (for selecting an appropriate frequency band)
- In order to transmit the **i -th symbol**, the following signal is used

$$S_i(t) = \begin{cases} \sqrt{\frac{2E}{T}} \cos(2\pi F_i t), & 0 \leq t \leq T \\ 0 & \text{elsewhere} \end{cases}$$

Example BFSK

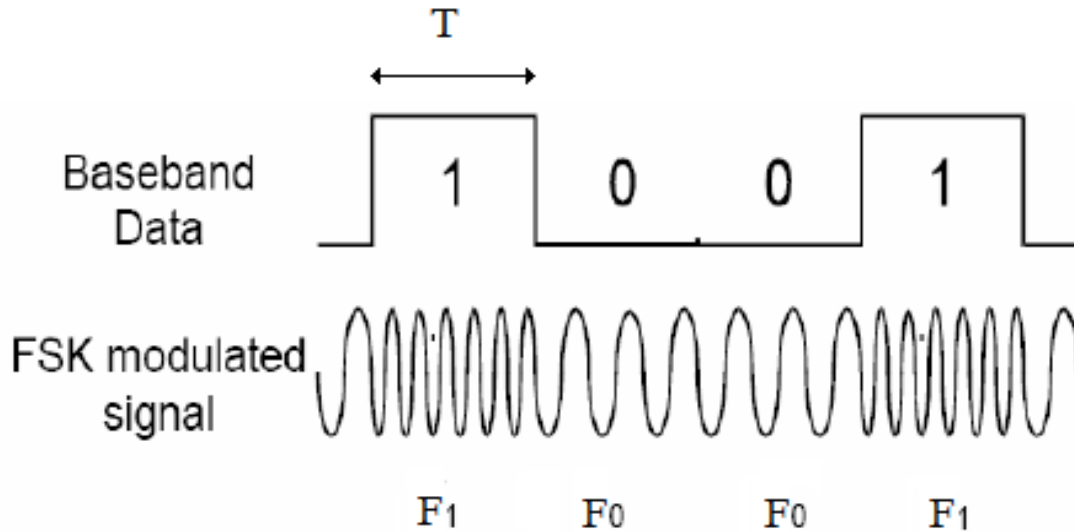

$$F_0 = \frac{n+1}{2T}$$

$$F_1 = \frac{n+2}{2T}$$

- Bit 0 corresponds to: $\sqrt{\frac{2E}{T}} \cos(2\pi F_0 t)$
- Bit 1 corresponds to: $\sqrt{\frac{2E}{T}} \cos(2\pi F_1 t)$

FSK demodulation



- Consider a **vector space with base vectors**

$$b_i = \sqrt{\frac{2}{T}} \cos(2\pi F_i t), \quad i = 1, 2, \dots, M$$

- The transmitted & the received signals correspond to **different points on this vector space**
 - This is due to noise & the channel gain
- The largest coordinate of the received signal corresponds to the transmitted symbol with high probability

BFSK demodulation

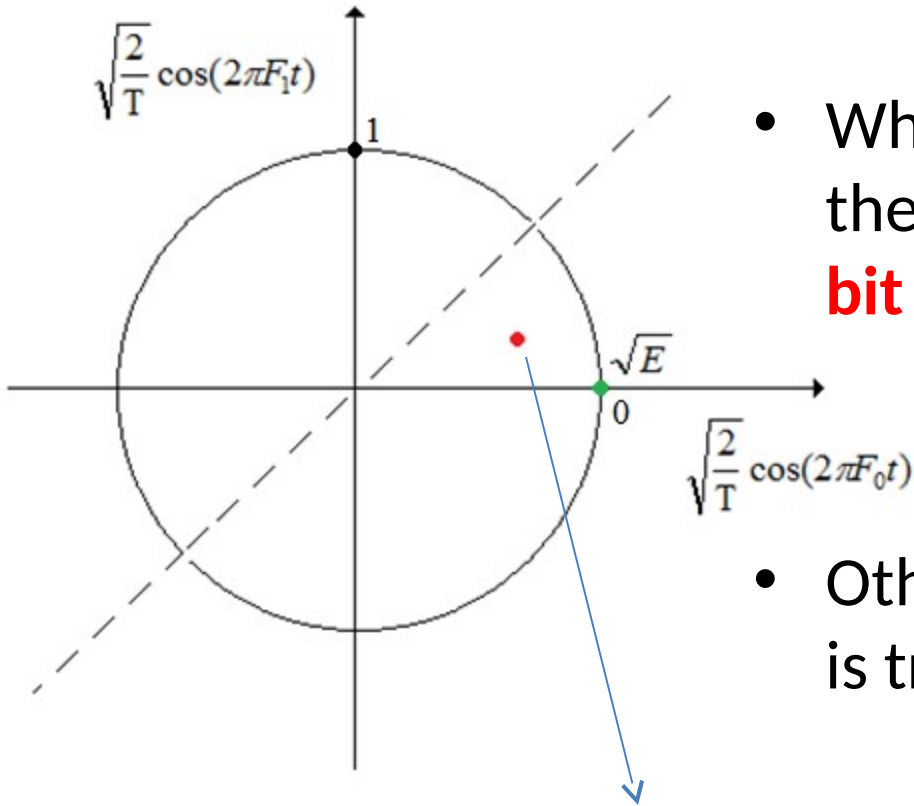

- When the received signal is below the dashed line, it is assumed that **bit 0** is transmitted

- Otherwise, it is assumed that **bit 1** is transmitted

- Received signal
- Transmitted signal

Due to path loss, there is an energy attenuation
Resulting to a received signal residing in the circle
instead of **on the periphery**

However, due to constructive phenomena, in other situations, the received signal may reside outside of the circle

Signal Representation



- each signal can be written as a linear combination of a sinusoidal and cosusoidal functions

$$c * \sin(2\pi F_c * t + \varphi) = a * \sin(2\pi F_c * t) + b * \cos(2\pi F_c * t)$$

Οι βάσεις του χώρου είναι το ημίτονο και το συνημίτονο. Επομένως το παραπάνω σήμα μπορεί να αντιπροσωπευθεί με ένα σημείο (a,b)



PDF of the received signal

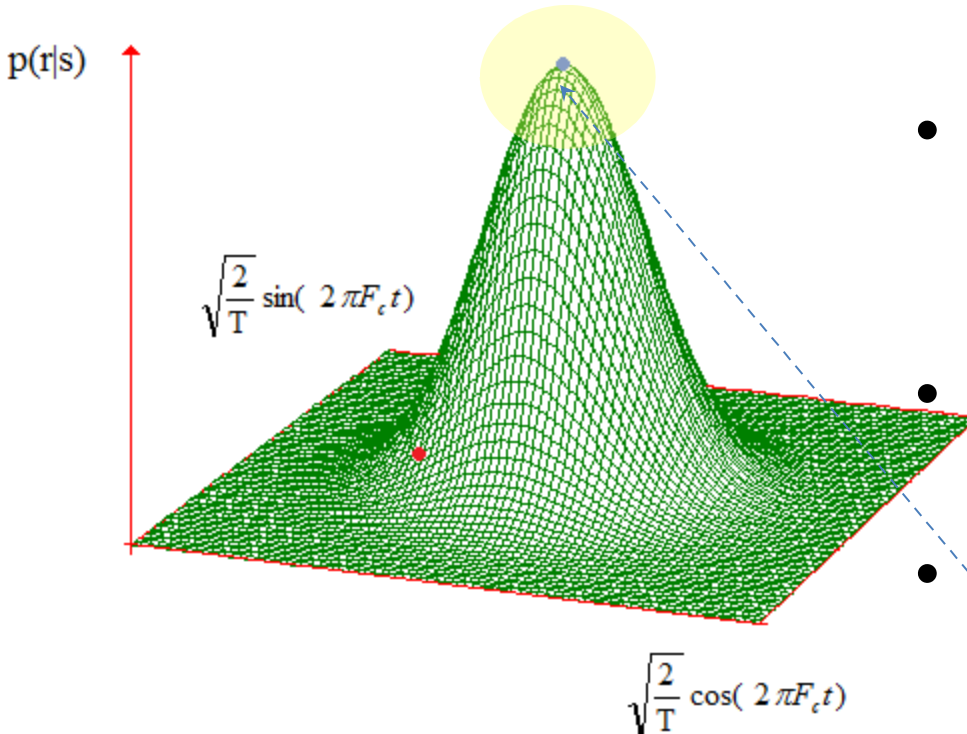

- Probability that the received signal would lie at a particular point: 2D Gaussian
- The probability space of the PDF is the vector space of the signals
- The **peak of the distribution** corresponds to the transmitted signal

- s : transmitted signal
- r : received signal

Όσο μεγαλύτερος είναι ο **θόρυβος** τόσο πιο μεγάλο είναι το **standard deviation της Gaussian κατανομής**:
Μεγαλύτερη η πιθανότητα να λάβουμε ένα σήμα διαφορετικό από αυτό που έστειλε ο πομπός.

PSK modulation



- The alphabet contains $M = 2^k$ different symbols
- To transmit the i -th symbol, the following signal is transmitted

$$S_i(t) = \begin{cases} \sqrt{\frac{2E}{T}} \cos(2\pi F_c t + \phi_i), & 0 \leq t \leq T \\ 0 & \textit{elsewhere} \end{cases}$$

- Signals $S_i(t)$ are **linearly dependent**
they can be represented by linear combination of the vectors:

$$b_1 = \sqrt{\frac{2}{T}} \cos(2\pi F_c t)$$

$$b_2 = \sqrt{\frac{2}{T}} \sin(2\pi F_c t)$$

Example BPSK

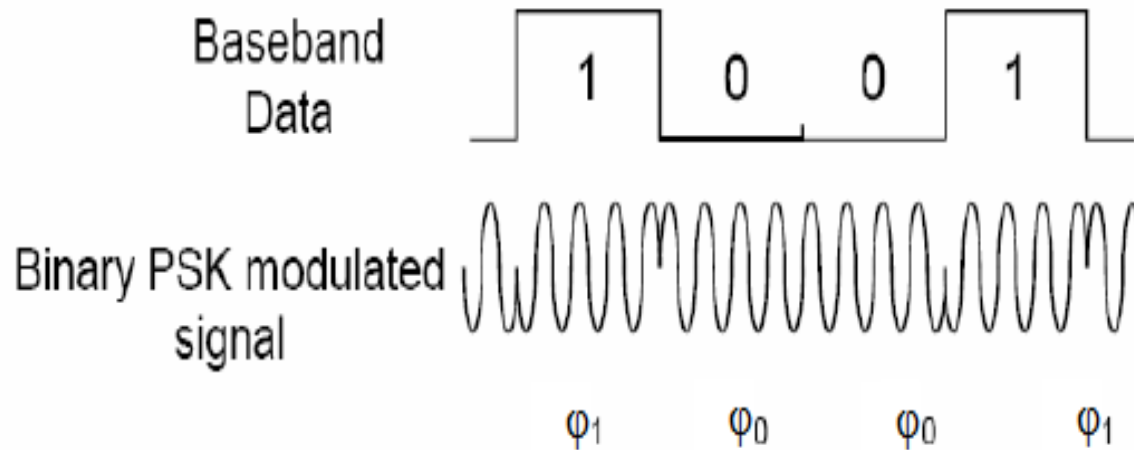

$$\phi_0 = -\pi / 2$$

$$\phi_1 = \pi / 2$$

- Bit 0 corresponds to : $\sqrt{\frac{2E}{T}} \cos(2\pi F_c t - \pi / 2)$
- Bit 1 corresponds to: $\sqrt{\frac{2E}{T}} \cos(2\pi F_c t + \pi / 2)$

QPSK

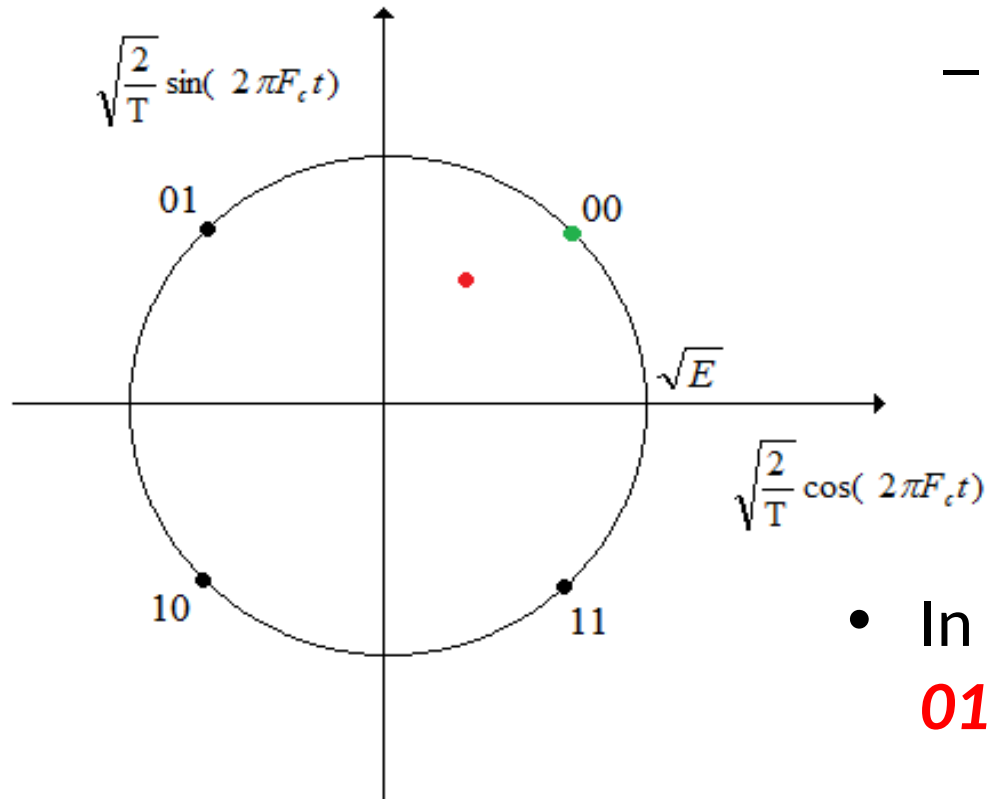

- Received signal
- Transmitted signal

– If the received signal lies in the 1st quadrant, **assume** that the **00 is transmitted**

- In the 2nd quadrant, assume that **01 is transmitted**, etc

8PSK

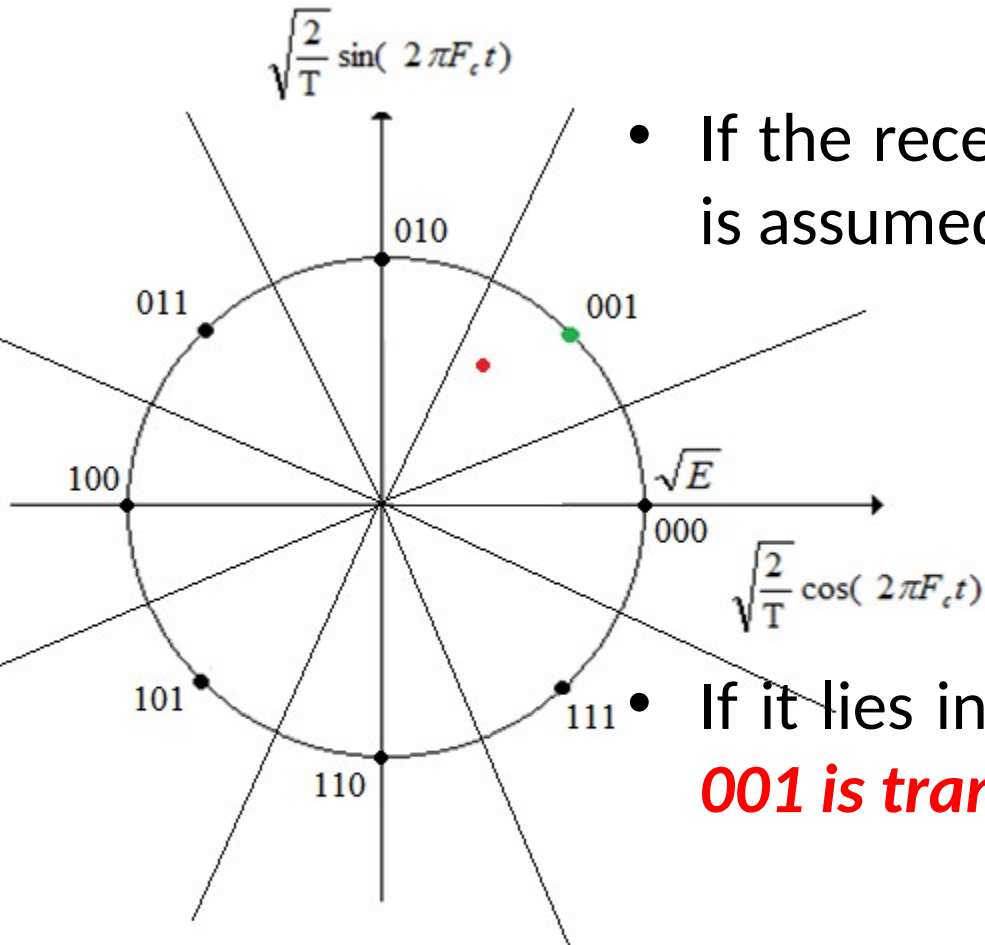

- If the received signal lies in the 1st area, it is assumed that the **000 is transmitted**

- If it lies in the 2nd area, it is assumed that **001 is transmitted** etc

- Received signal
- Transmitted signal

QAM modulation



- This modulation scheme is an expansion of PSK
 - A **single carrier frequency** is used (F_c)
 - The transmitted & received signals are represented as linear combinations of:

$$b_1 = \sqrt{\frac{2}{T}} \cos(2\pi F_c t) \quad b_2 = \sqrt{\frac{2}{T}} \sin(2\pi F_c t)$$

- The difference is that **not only the phase but also the amplitude** of the carrier signal may vary

Example: 16QAM

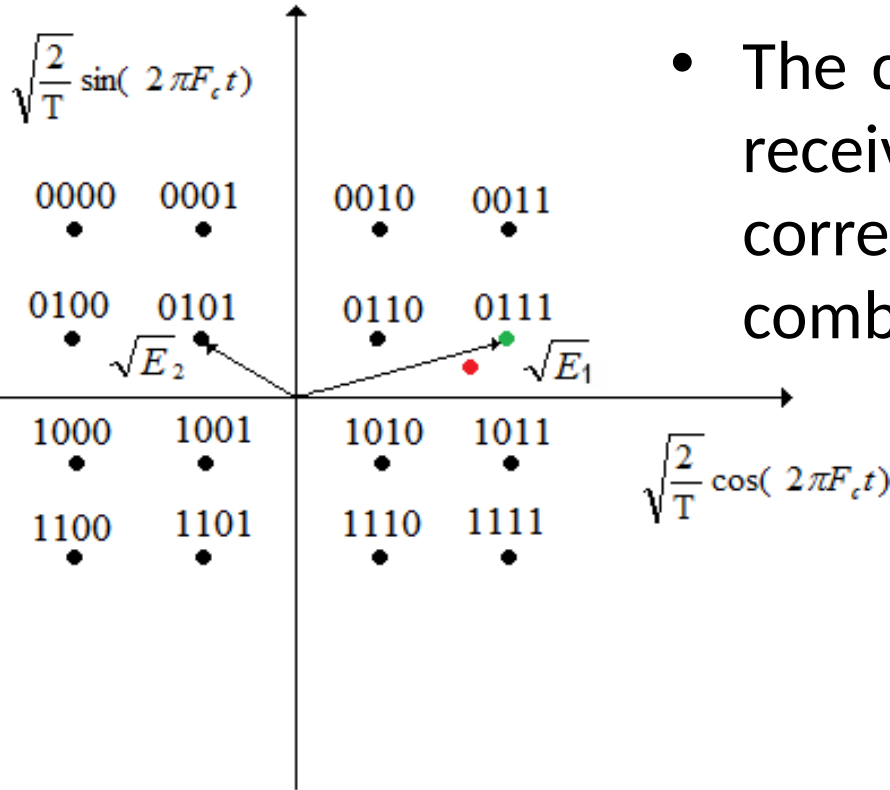

- The constellation point, closer to the received signal, is assumed to correspond to the transmitted bit combination

- Received signal
- Transmitted signal



PDF of the received signal

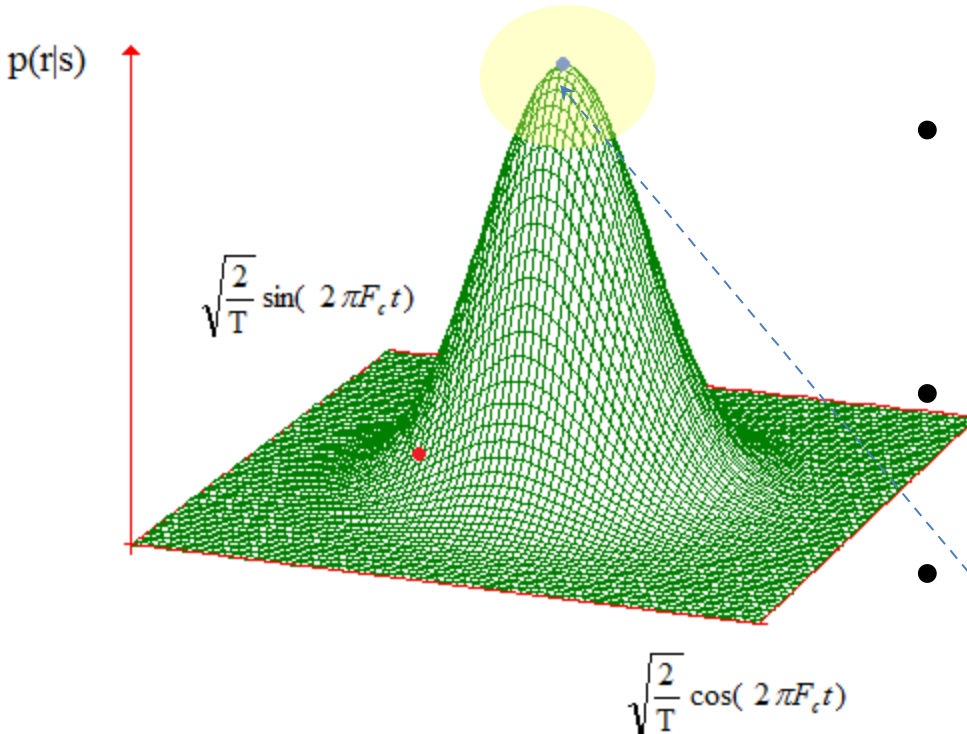

- Probability that the received signal would lie at a particular point: 2D Gaussian
- The probability space of the PDF is the vector space of the signals
- The **peak of the distribution** corresponds to the transmitted signal

- s: transmitted signal
- r: received signal

Όσο μεγαλύτερος είναι ο **θόρυβος** τόσο πιο μεγάλο είναι το **standard deviation της Gaussian κατανομής**:
Μεγαλύτερη η πιθανότητα να λάβουμε ένα σήμα διαφορετικό από αυτό που έστειλε ο πομπός.

BER calculation



8PSK

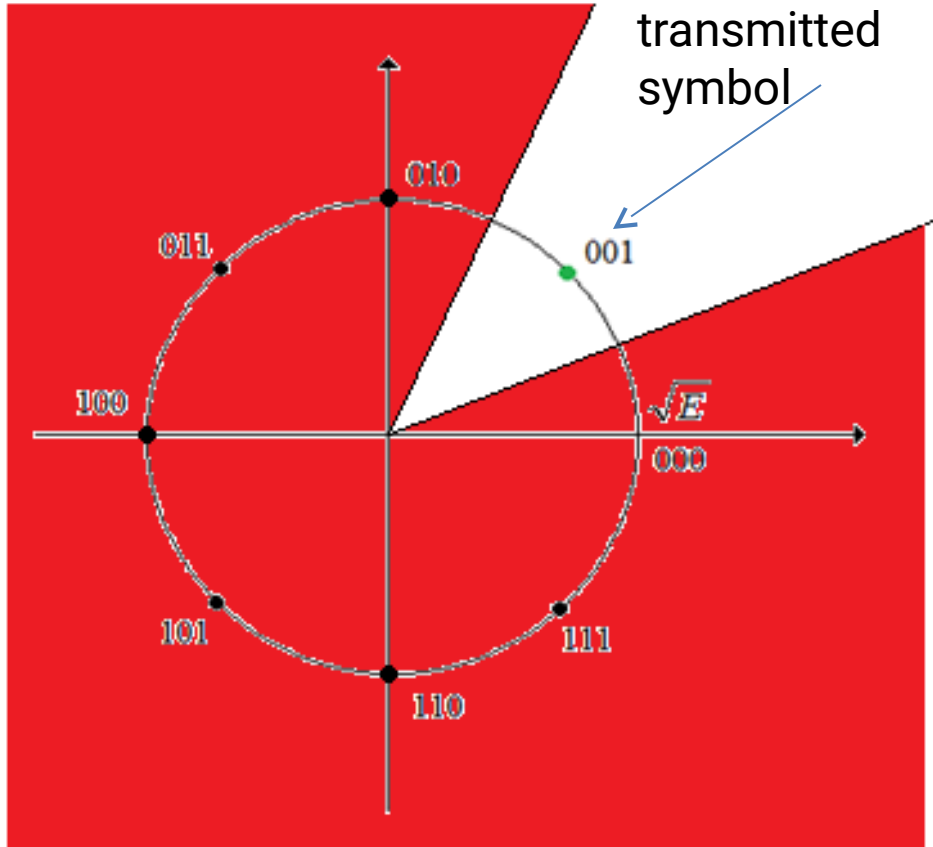

QPSK

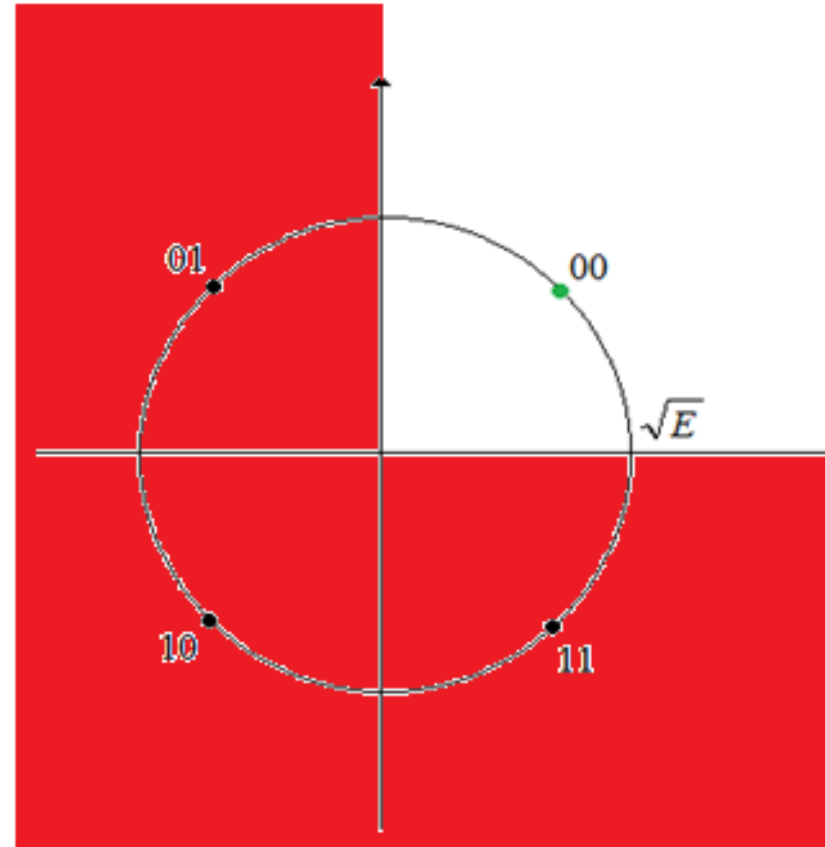

- To calculate BER: compute the integral of the signal PDF in red zone
- For 8PSK: red zone is larger and yields a higher BER
- The additional red zones in 8PSK have large probability mass ~
BER is significantly higher in 8PSK than in QPSK

BER calculation



8PSK

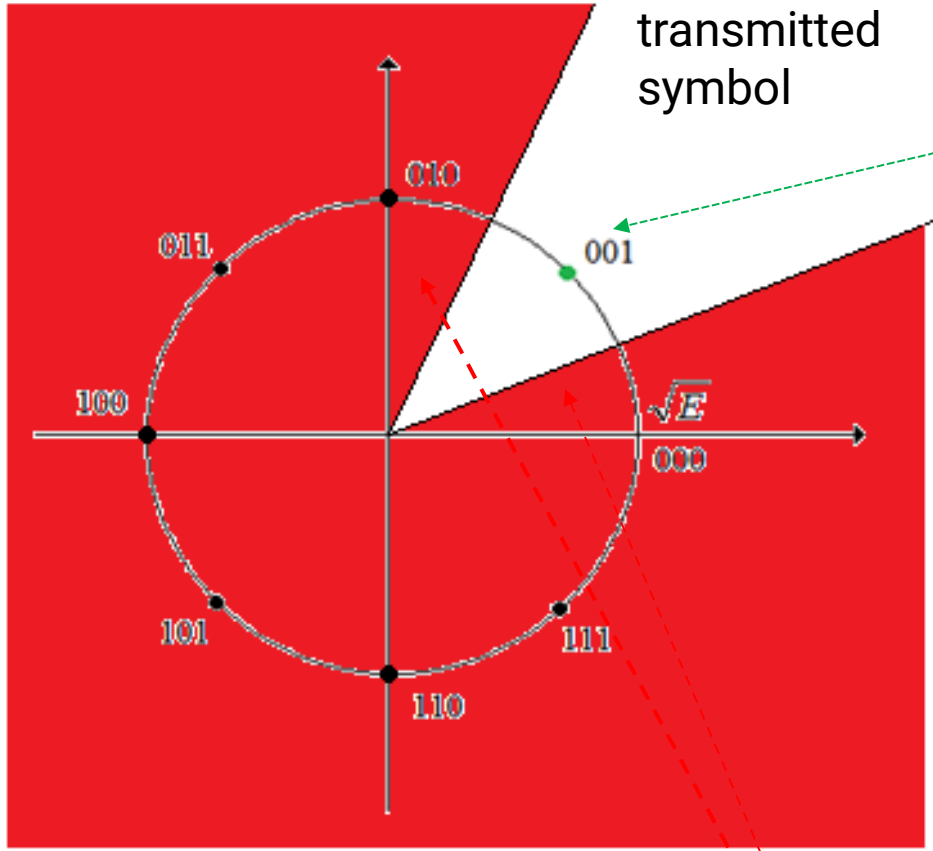

QPSK

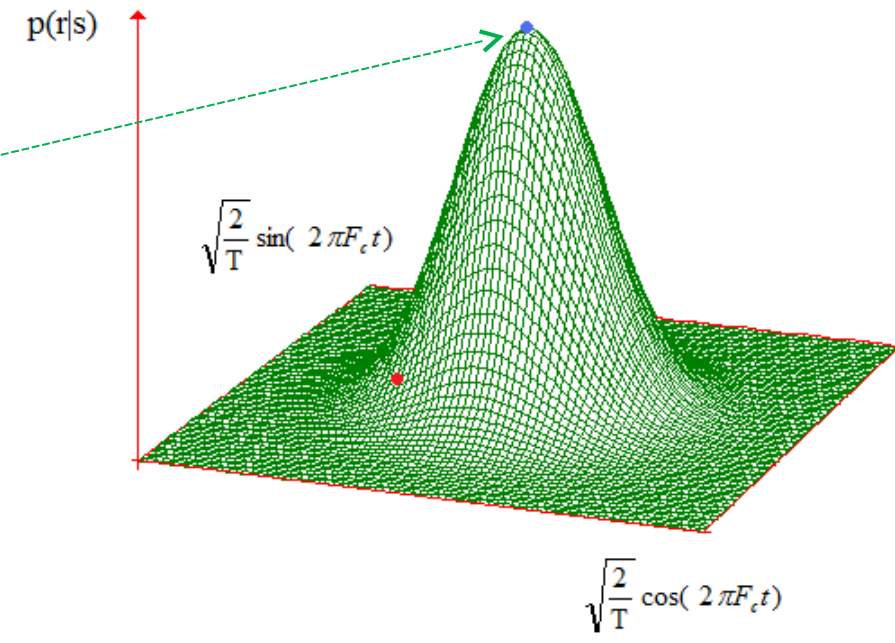

- s: transmitted signal
- r: received signal

The peak of the 2D Gaussian corresponds to the position of the transmitted signal s . The contribution to the BER of these regions is larger.

Gaussian frequency shift keying (GFSK)



- Encodes data as a **series of frequency changes in a carrier**
- **Noise usually changes the amplitude of a signal**
- Modulation that **ignores amplitude** (e.g., broadcast FM)
 - Relatively immune to noise
- Gaussian refers to the shape of radio pulses

2GFSK



Two different frequencies

- To transmit **1**
 - The carrier *frequency is increased* by a certain deviation
- To transmit **0**
 - The carrier *frequency is decreased* by the same deviation

2GFSK of letter M ("1001101")



- When **1 is transmitted**, frequency rises to the center frequency **plus an offset**
- When **0 is transmitted**, frequency drops by the same offset

The horizontal axis represents time and is divided into **symbol periods**. Around **the middle of each period**, the **receiver measures the frequency** of the transmission and **translates that frequency into a symbol**.

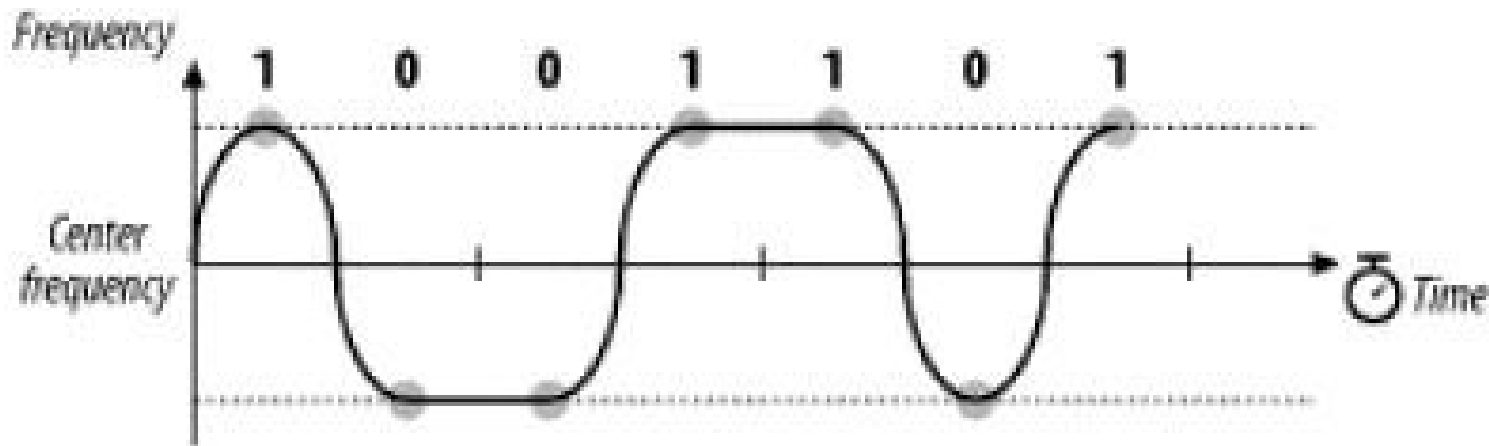

4GFSK



Extending GFSK-based methods to higher bit rates

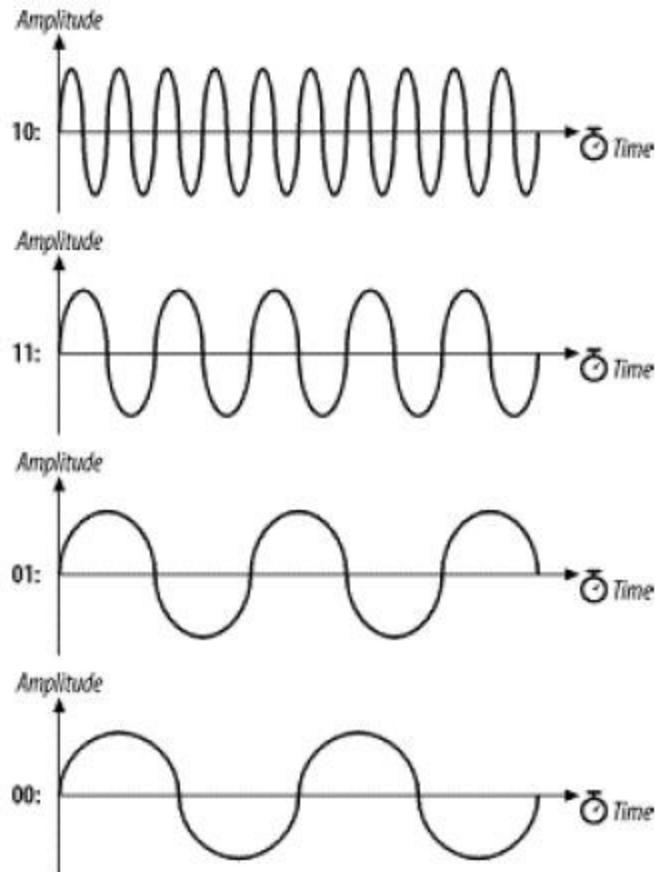

2GFSK vs. 4GFSK



Distinguishing between two levels is fairly easy

Four is harder:

- Each **doubling of the bit rate** requires that **twice as many levels** be present
or the RF components distinguish **between ever smaller frequency changes**
- This issue practically limits the FH PHY to 2 Mbps

Differential Phase Shift Keying (DPSK)



- Basis of **802.11 DSSS**
- **Absolute phase of waveform is not relevant**
- **Only changes in the phase encode data**
- Two carrier waves
 - Shifted by a half cycle relative to each other
 - Reference wave: **encodes 0**
 - Half-cycle (180°) shifted wave: **encodes 1**

Differential quadrature phase shift keying (DQPSK)



Symbol	Phase Shift
00	0
01	90°
11	180°
10	270°

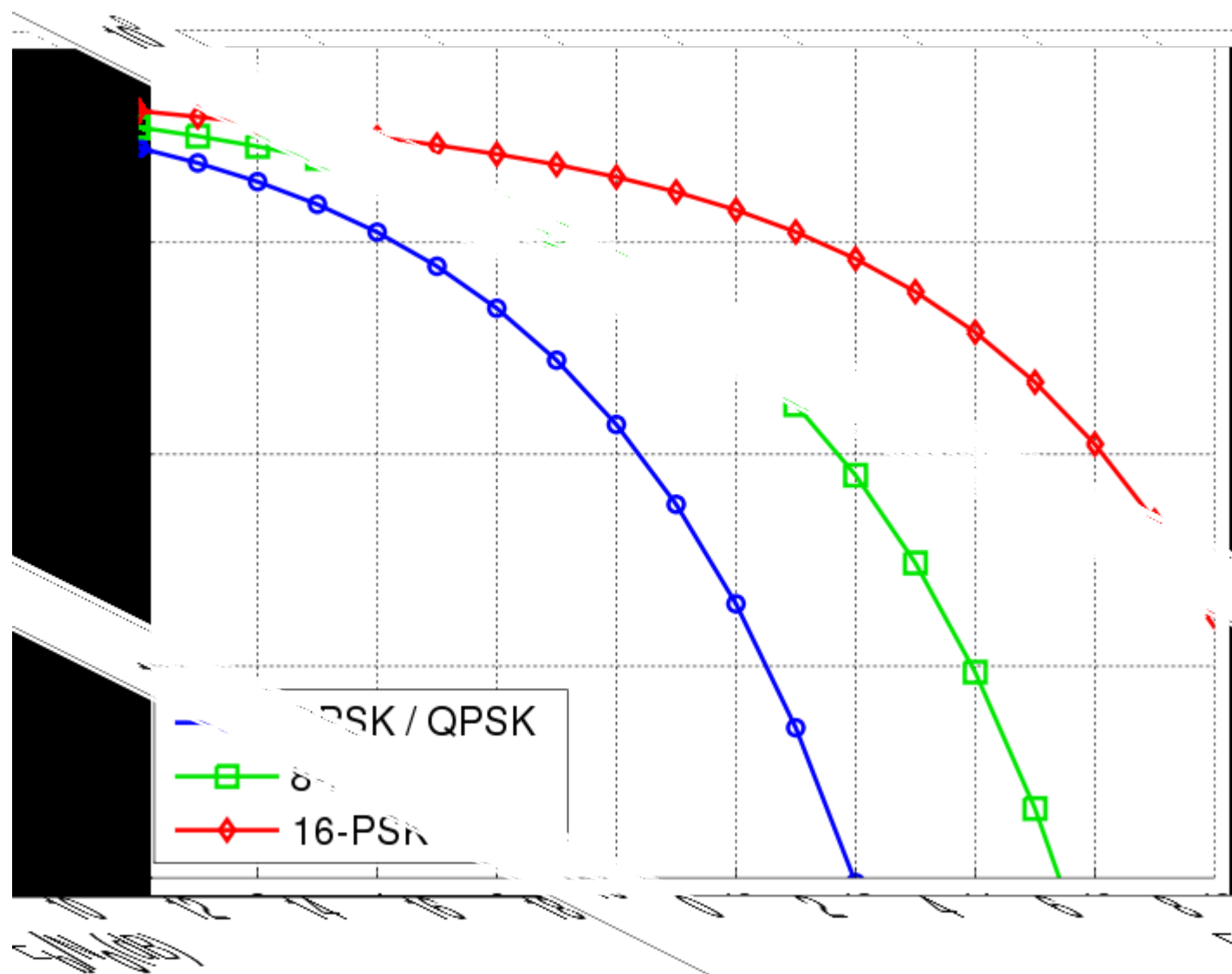

E_b : energy
 N_0 : noise

Multiple Access Techniques



- **Frequency Division Multiple Access (FDMA)**
 - Each device is allocated a **fixed frequency**
 - Multiple devices share the available radio spectrum by using different frequencies
- **Code Division Multiple Access (CDMA)**
- **Direct Sequence Spread Spectrum (DSSS)**
- **Frequency Hopping (FH)**
- **Orthogonal Frequency Division Multiplexing (OFDM)**

Spread spectrum



- Traditional radio communications focus on cramming as **much signal** as possible into as **narrow a band** as possible
- Spread spectrum use mathematical functions to diffuse signal power over large range of frequencies
- Spreading the transmission over wide band makes transmission look like noise to a traditional narrowband receiver

Spread Spectrum Technology



- Spread radio signal over a wide frequency range several magnitudes higher than minimum requirement
- Use of noise-like carrier waves and bandwidths much wider than that required for simple point-to-point communication at the same data rate
- Electromagnetic energy generated in a particular bandwidth is deliberately spread in the frequency domain, resulting in a signal with a wider bandwidth
- Used for a variety of reasons
 - establishment of secure communications
 - increasing resistance to natural [interference](#) and [jamming](#)
 - prevent detection
- Two main techniques:
 - Direct sequence (DS)
 - Frequency hopping (FH)



Frequency division multiple access

- First generation mobile phones used it for radio channel allocation
- Each user was given an exclusive channel
- Guard bands were used to ensure that **spectral leakage** from one user did not cause problems for users of adjacent channels



Frequency

Problems with FDMA ?



- Wasting transmission capacity with unused guard bands ...

Code division multiple access (CDMA)



- CDMA assigns a different code to each node
- Codes **orthogonal to each other** (i.e inner-product = 0)
- Each node uses its unique code to encode the data bits it sends
- Nodes can **transmit simultaneously**
- **Multiple nodes per channel**
- Their respective receivers
 - Correctly receive a sender's encoded data bits
 - **Assuming the receiver knows the sender's code** in spite of interfering transmissions by other nodes

CDMA Example

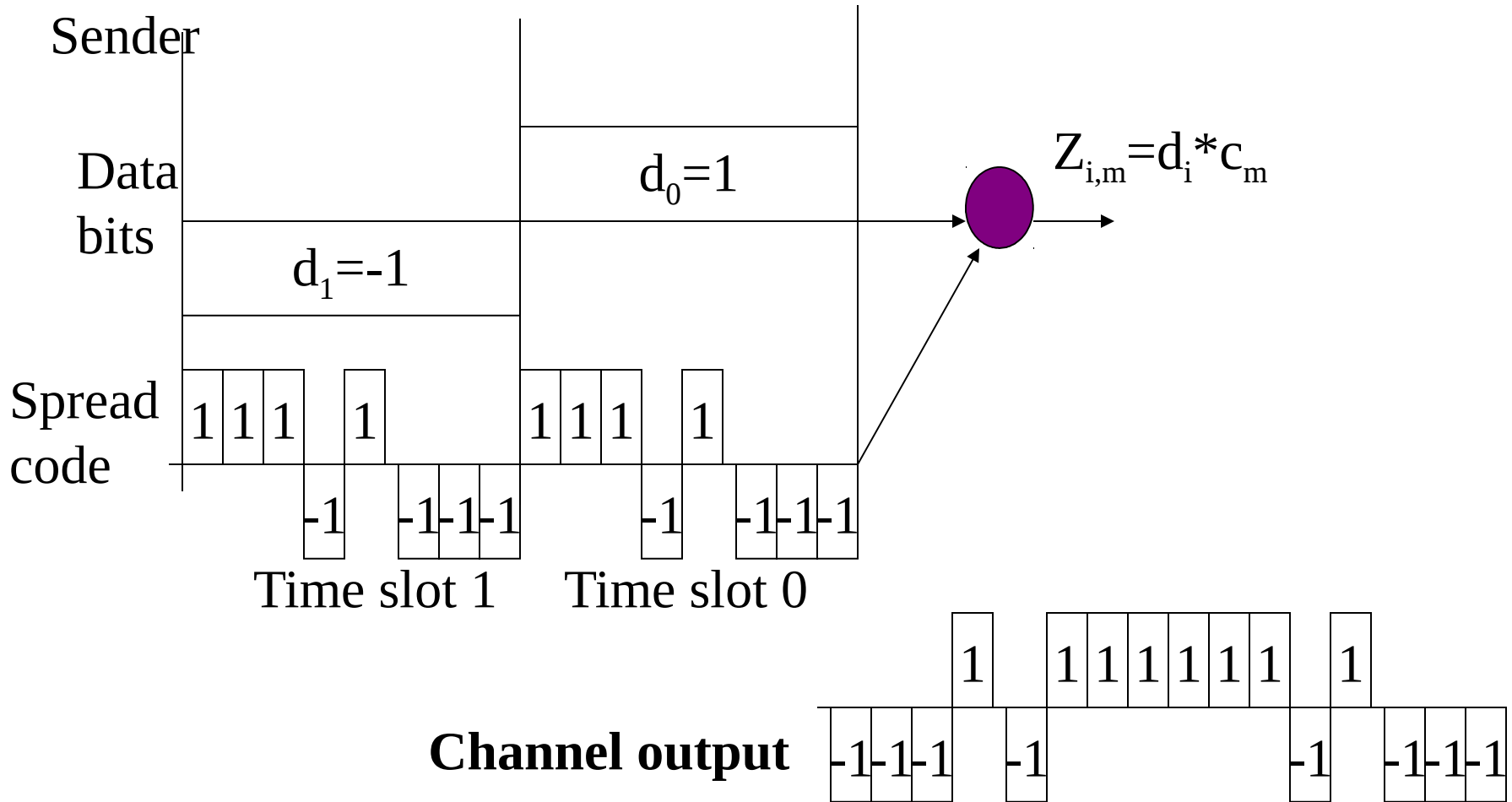

CDMA Example (cont'd)



- When no interfering senders, receiver would
 - Receive the encoded bits
 - Recover the original data bit, d_i , by computing

$$d_i = \frac{1}{M} \sum_{m=1}^M c_m$$

- **Interfering transmitted bit signals are additive**

CDMA Philosophy



- Interference seen by any user is made as similar to white Gaussian noise as possible
- Power of that interference is kept to a minimum level and as consistent as possible
- The above are achieved by the following
 - Tight power control among users within the same cell
 - Making the received signal of every user as random looking as possible via modulating the coded bits onto a long pseudo-noise sequence
 - Averaging the interference of many users in nearby cells. This averaging makes the aggregate interference to look as Gaussian
reduces the randomness of the interference level due to varying locations of the interference



Inverts the “spreading process”

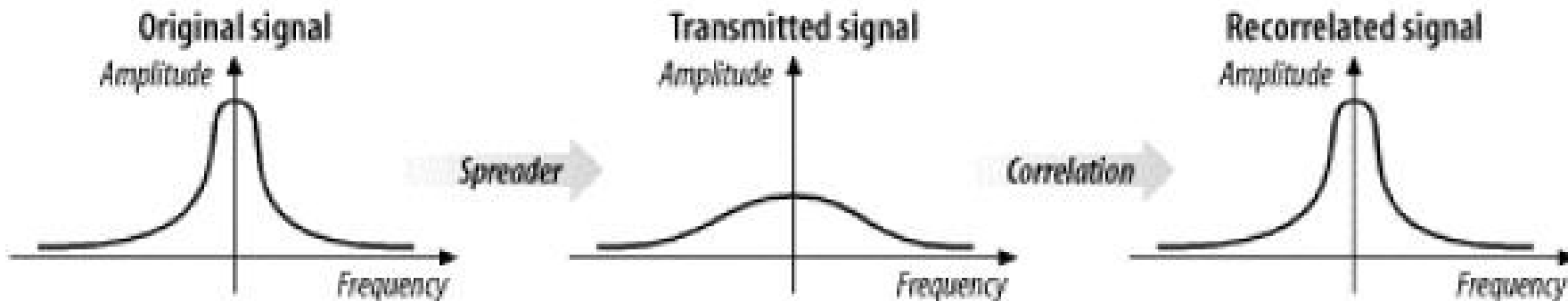

Flatten the amplitude across a relatively wide band

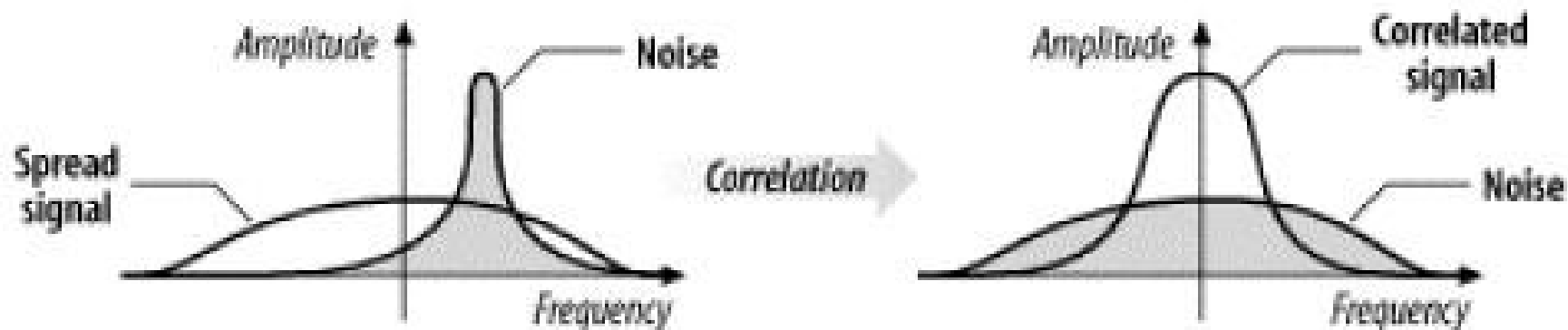

The receiver's correlation function effectively ignores narrowband noise

Orthogonal Frequency Division Multiplexing



- Related to the Frequency Division Multiplexing (FDM)
- Distributes the data over a large number of carriers
 - **Spaced apart at precise frequencies**
- **Encodes portion of the signal across *each sub-channel in parallel***
- This spacing provides the "**orthogonality**"
 - Preventing demodulators from seeing other frequencies

Provides

- High spectral efficiency
- Resiliency to RF interference
- Lower multi-path distortion

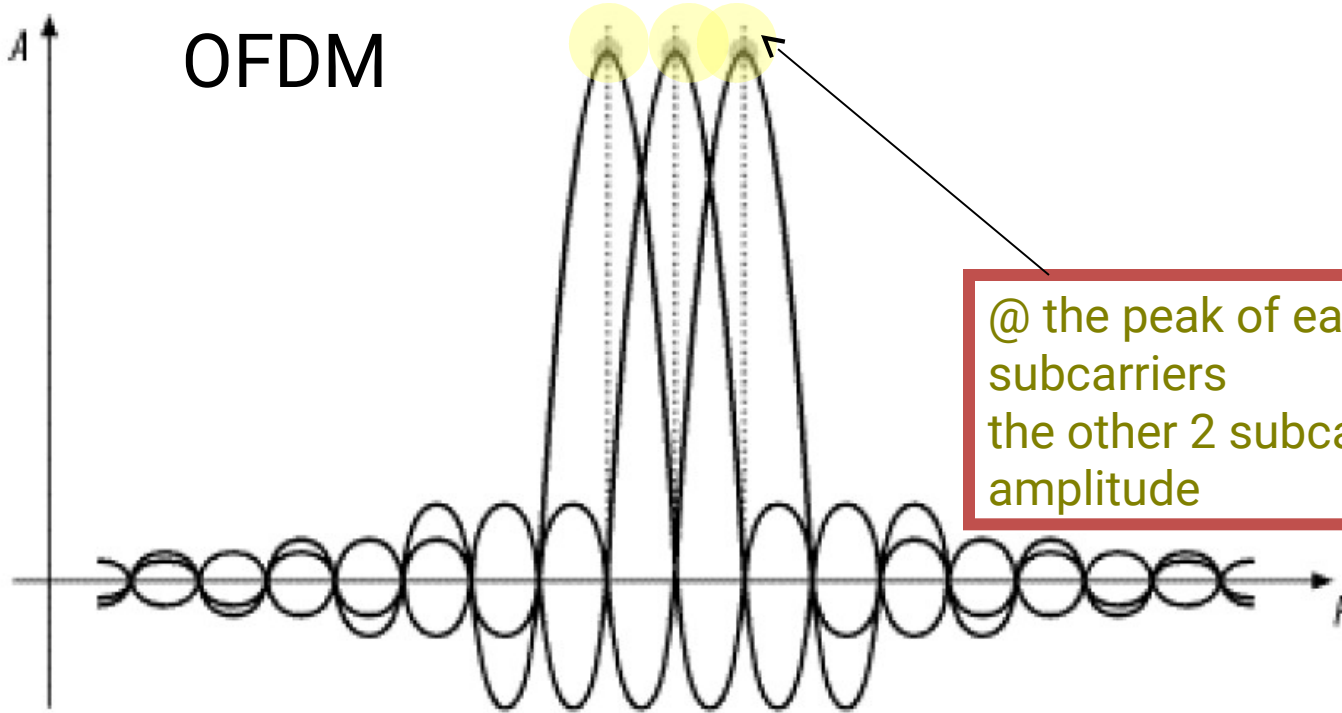

@ the peak of each of the subcarriers the other 2 subcarriers have 0 amplitude

- Orthogonality is best seen in the frequency domain, looking at a spectral breakdown of a signal
- The frequencies of the subcarriers are selected so that at each subcarrier frequency, all other subcarriers do not contribute to the overall waveform
- The signal has been divided into its three subcarriers
- The peak of each subcarrier, shown by the heavy dot at the top, encodes data
- The subcarrier set carefully designed to be orthogonal

FDM vs. OFDM

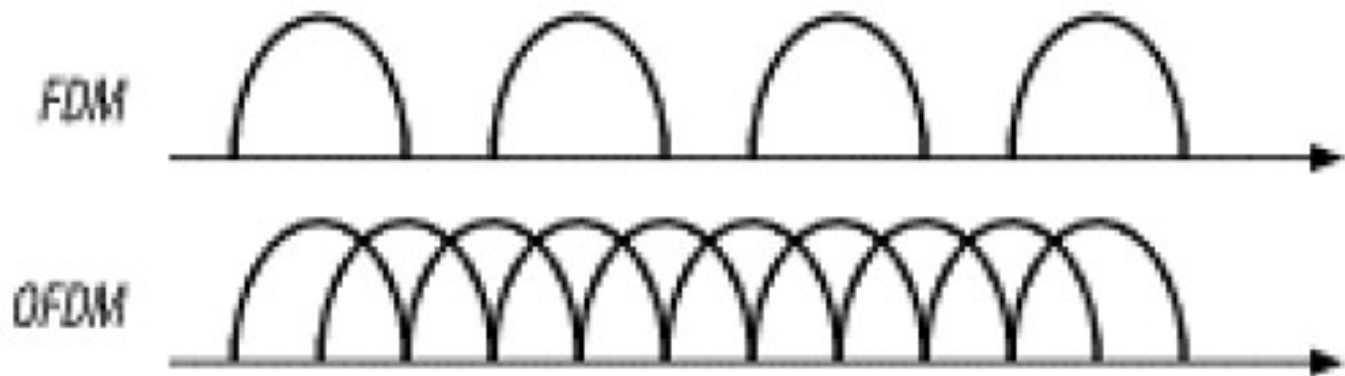

Example of OFDM Transmitter & Receiver

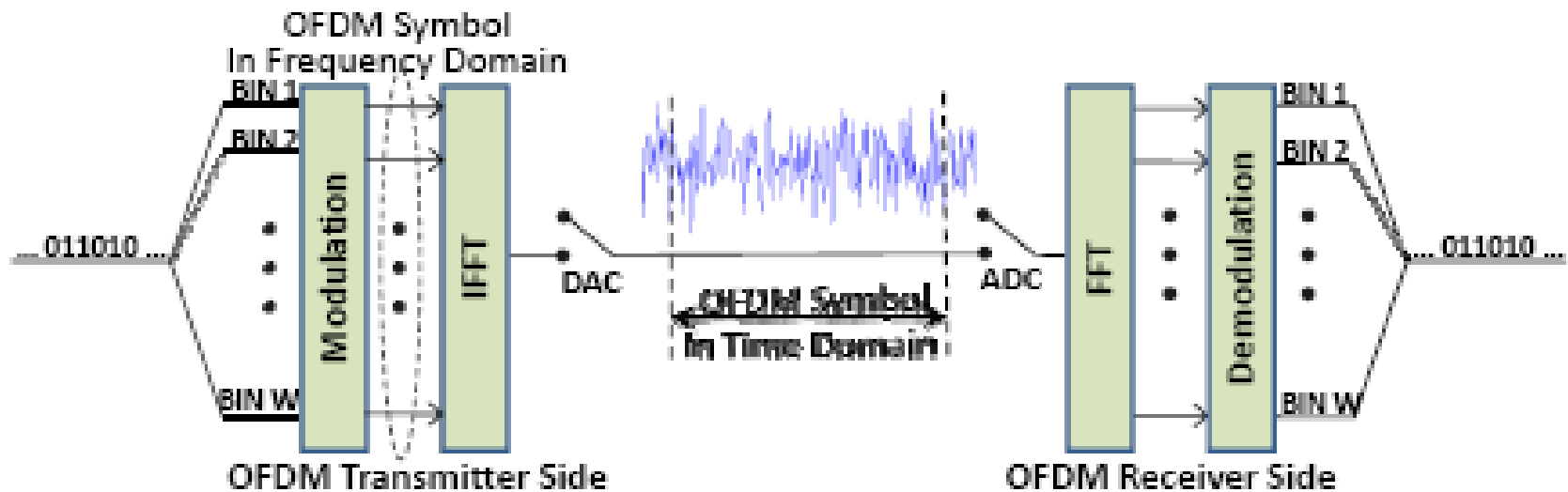
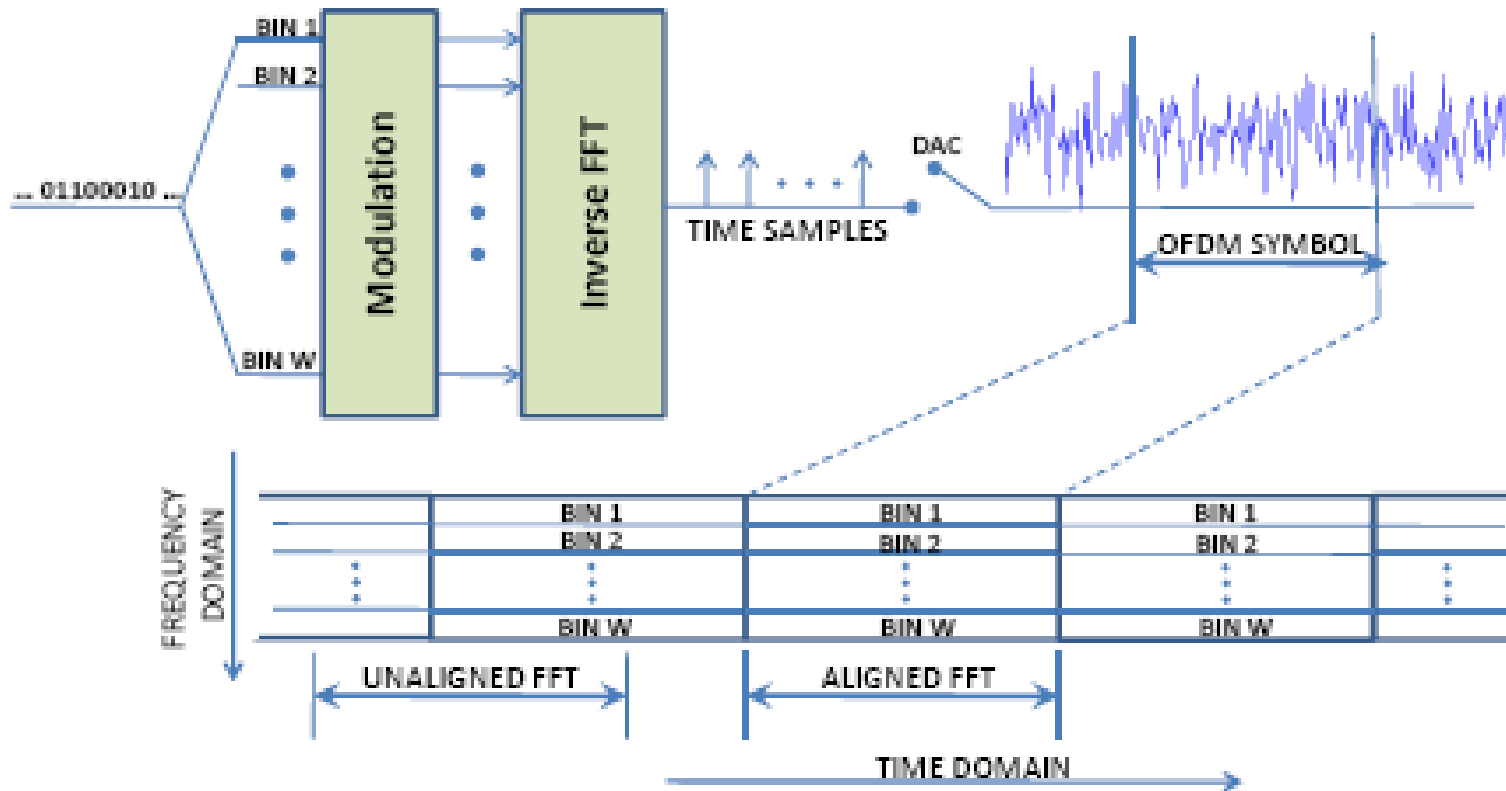
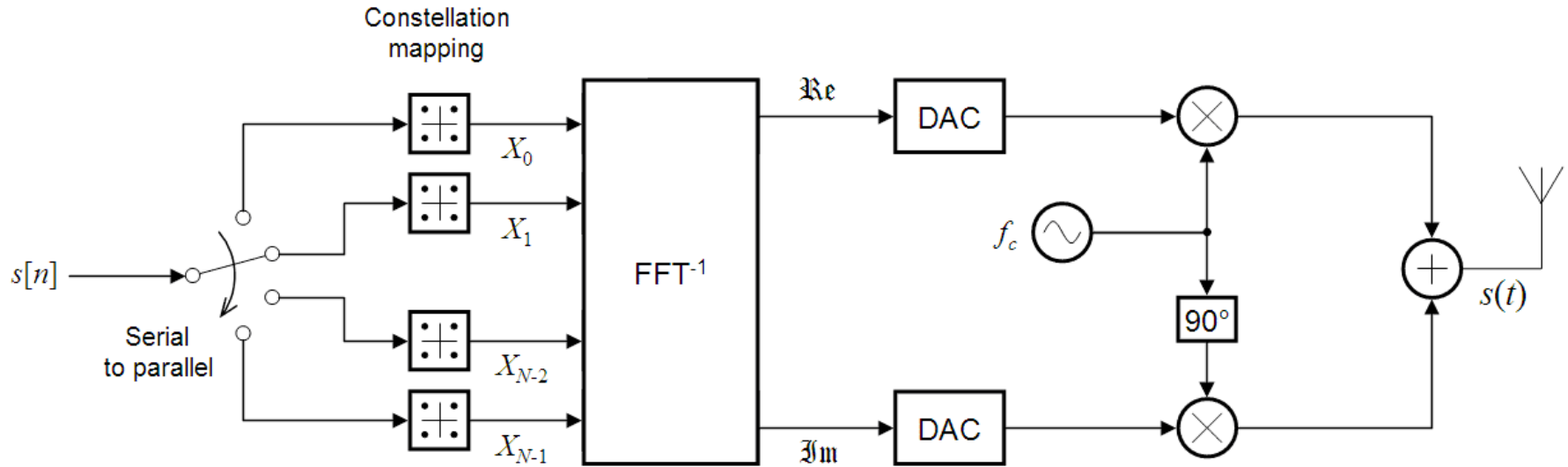

Figure 1: Schematic of an OFDM System

Example of OFDM



OFDM Modulation



- The bit stream is divided into N parallel subflows
- The symbols of each subflow are modulated using **MPSK** or **MQAM**
- Resulting complex numbers are fed to a module that performs FFT^{-1}
- Finally the signal is converted from digital to analog, brought to the RF frequencies, and then fed to the antenna of the transmitter

OFDM Demodulation

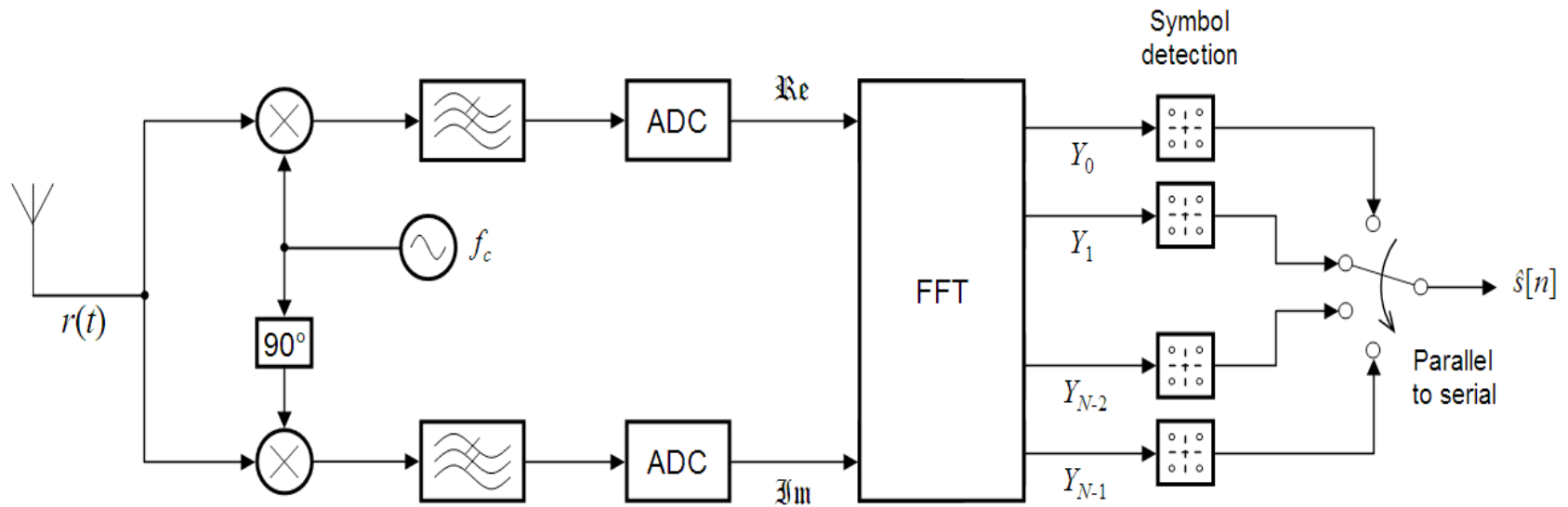

- At the receiver the inverse procedure is followed
 1. The signal is brought down to baseband & is converted from analog to digital
 2. FFT is performed \Rightarrow produces the transmitted symbols

Frequency Selective Fading



- The frequency response of a fading channel is not constant within the available bandwidth
 - The channel gain may **vary for different frequencies** of the transmitted signal
 - Channel gain: συντελεστής που εκφράζει την επίδραση στο μεταδιδόμενο σήμα

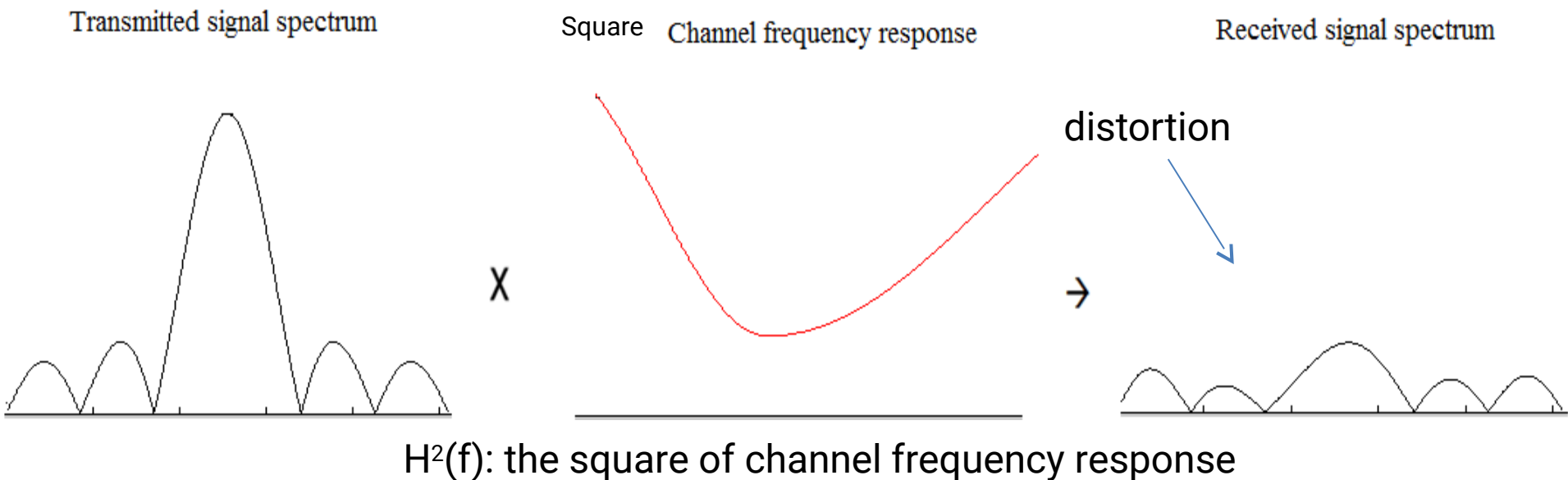

Το παραπάνω παράδειγμα δείχνει ένα κακής ποιότητας κανάλι, μια και παραμορφώνει σημαντικά τα φασματικά χαρακτηριστικά του μεταδιδόμενου σήματος (πχ κύριος λοβός έχει σχεδόν εξαφανιστεί)

Use OFDM



- To reduce the effect of frequency selective fading
 - The total available bandwidth is divided into N frequency bins
 - The number N is selected such that the **channel frequency response** is **almost constant at each bin** (*Flat fading*)

Υποκανάλια **μικρού εύρους συχνότητας** ώστε να υπάρχει μόνο εξασθένηση ή ενδυνάμωση και όχι παραμόρφωση.

Transmitted signal spectrum

Square

Channel frequency response

Received signal spectrum

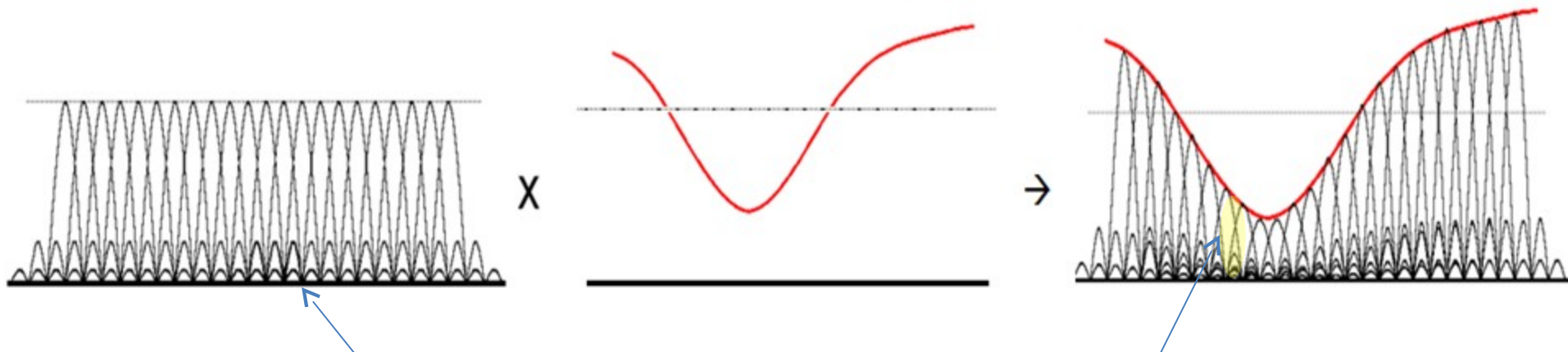

Multiple transmitted signals (one symbol per frequency bin)

Note: larger symbol duration per bin (compared to spread spectrum schemes)

There is (a different) attenuation at each bin but the **spectral characteristics of the signal remain the same** (μόνο το πλάτος του σήματος αλλοιώνεται, αλλά όχι η παρουσία των λοβών/"σχήμα" τους)

CDMA vs. OFDM



- OFDM encodes **single transmission** into **multiple subcarriers**
- CDMA puts **multiple transmissions** into **single carrier**

Frequency Hopping



- **Timing the hops accurately** is the key
- **Transmitter and receiver in synch**
- Each frequency is used for small amount of time (dwell time)
- **Orthogonal hopping** sequences
- Beacons include timestamp and hop pattern number
- Divides the ISM band into a series of 1-MHz channels
- No sophisticated signal processing required
 - To extract bit stream from the radio signal

Frequency Hopping



Timing the hops accurately is the challenge

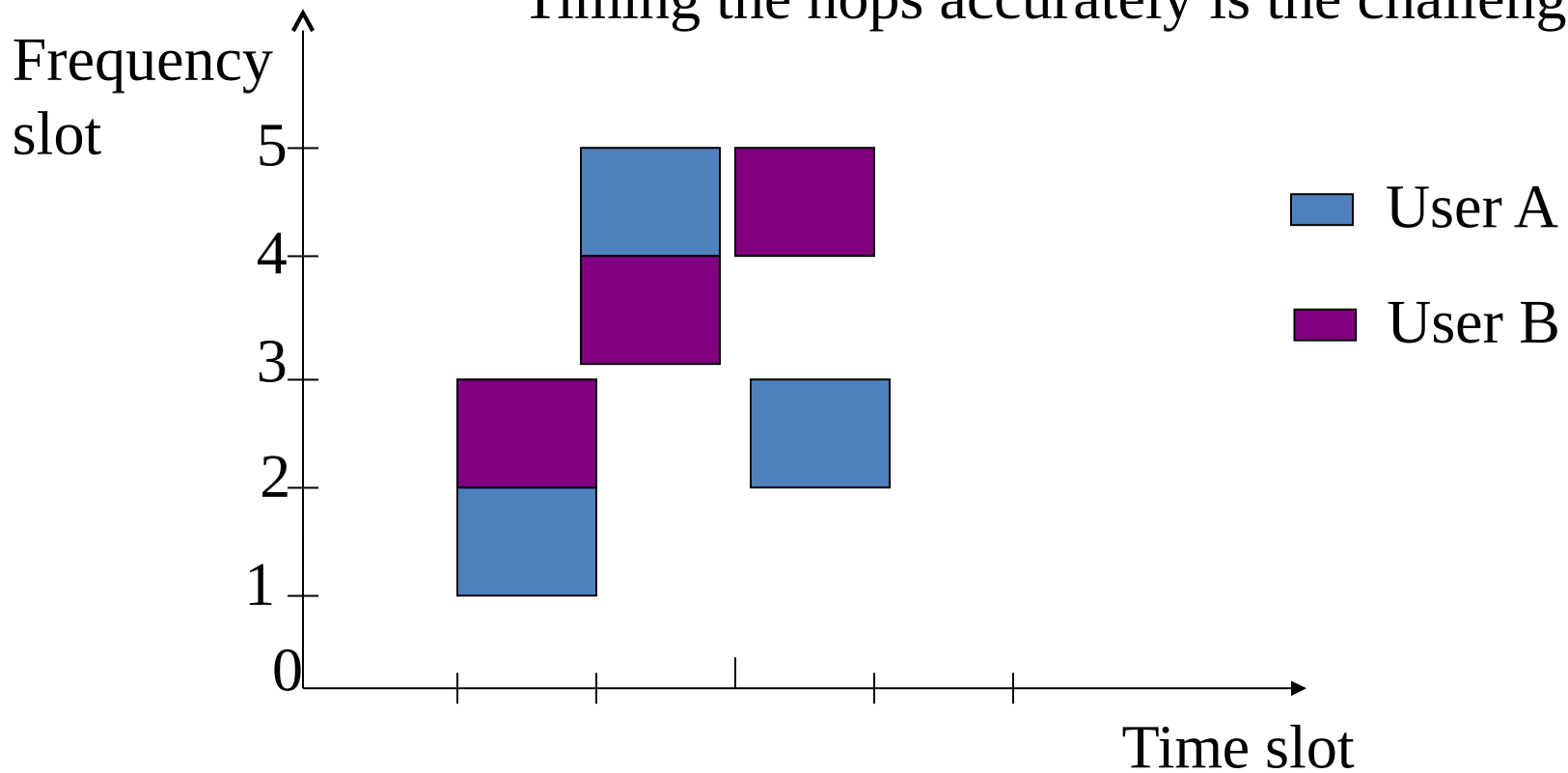

Wireless network interfaces



- Measure the energy level in a band
- Energy detection is cheap, fast, & requires **no knowledge** of the characteristics of the signal
- However, choosing energy thresholds is not robust across a wide range of SNRs
- Though more sophisticated mechanisms, such as matched filter detection, are more accurate
 - they require knowledge of the transmitted signal (e.g., modulation, packet format, pilots, bandwidth), and thus work only for known technologies

Network Layers -(TCP/IP stack)



IEEE802.11

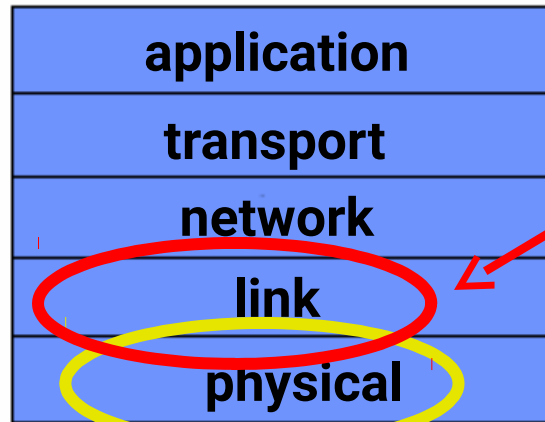

How neighboring devices access the link

In IEEE802.11, devices may compete for the broadcast channel

Transmission of sequence of bits & signals across a link

IEEE 802.11 Family



- **802.11b:**

Direct Sequence Spread Spectrum (DSSS) or Frequency Hopping (FH), operates at 2.4GHz, 11Mbps bitrate

- **802.11a:** between 5GHz and 6GHz uses orthogonal frequency-division multiplexing, up to 54Mbps bitrate

- **802.11g:** operates at 2.4GHz up to 54Mbps bitrate

- All have the same architecture & **use the same MAC protocol**

Coverage of a Cell



- The largest distance between the base-station & a mobile at which communication can **reliably** take place
- Cell coverage is constrained by the **fast decay of power with distance**
- To alleviate the inter-cell interference, neighboring cells use **different parts of the frequency spectrum**
- The rapid signal attenuation with distance is also helpful; it **reduces** the **interference between adjacent cells**

Spatial reuse

Frequency is reused at cells that are far enough

Hidden Node Problem

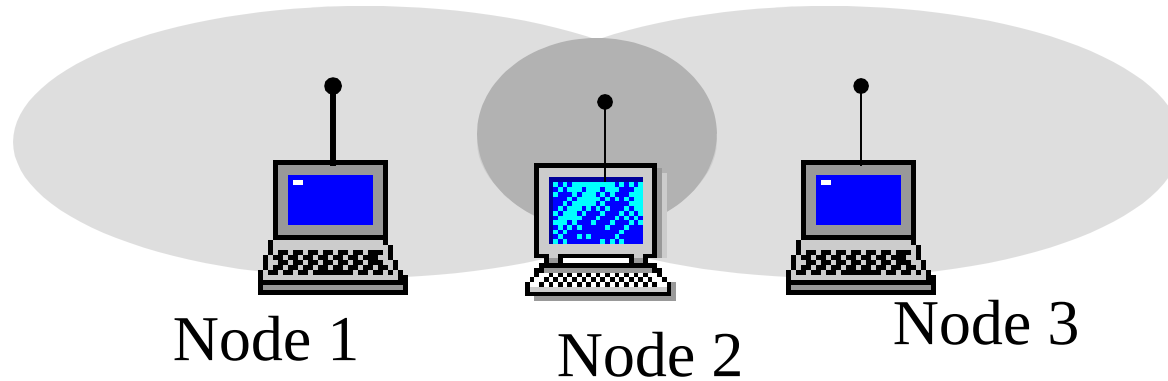

- From the perspective of node 1
 - Node 3 is hidden
- If node 1 and node 3 communicate simultaneously
 - Node 2 will be unable to make sense of anything
- Node 1 and node 3 would not have any indication of error
 - The collision was local to node2

Carrier-Sensing Functions



- Physical carrier-sensing
 - Expensive to build hardware for RF-based media
 - Transceivers can transmit and receive simultaneously
 - Only if they incorporate **expensive electronics**
 - Hidden nodes problem
 - Fading problem
 - Virtual carrier-sensing
 - Collision avoidance:
 - Stations delay transmission until the medium becomes idle
 - Reduce the probability of collisions
- } → Undetectable collisions

Next



- We will talk more about IEEE802.11 MAC and then about performance issues of wireless networks ...